

About this User Manual

EN

This manual contains all information you will need to initially install and operate your new TV. Also read the help texts which are being displayed at the bottom of the screen.



If this instruction manual does not give an answer or if 'Troubleshooting' does not solve your TV problem, you can call your Local Philips Customer or Service Centre. See the supplied Worldwide guarantee booklet.

Please, have the Model and Product number which you can find at the back or the bottom of your television set or on the packaging, ready, before calling the Philips customer support service.

Model: 42PF9641D/10

Product No:

Contents

Safety warnings	2	To make video and audio connections	43
Getting started	3	Side panel overview	44
Use of the remote control RC4401/01	5	Rear panel overview	45
Use of the option key	7	Connect:	
Keys at the right side of the TV	7	a VCR or DVD recorder	46
Introduction: Digital TV	8	two VCRs or VCR and DVD recorder ..	47
Switch the TV on	8	a satellite receiver	47
First time installation	9	a DVD player, HD receiver/game console	48
How to navigate through the menus	11	a DVD player or HD receiver	48
Use of the TV menu settings	13	a DVD player, satellite or HD receiver	49
Adjust picture menu settings	15	a PC	50
Adjust sound menu settings	18	a Home Cinema amplifier	51
Enjoy Ambilight	20	Use the Common Interface slot	52
Adjust feature menu settings	23	Select connected equipment	53
Search for and store TV channels	27	Record with your recorder	53
Rearrange the channel number list	30	Audio- and video equipment keys	54
Set your preferences	31	Troubleshooting	55
Select your connections	32	Annex 1 - Philips TV software upgrade	
Select a decoder channel number	32	with portable memory	57
Reset the factory settings	33	Annex 2 - Philips TV-Slideshow Format	
How to upgrade the TV software	33	with background music	60
Create your favourite list	34	Annex 3 - Philips TV - Digital camera	
EPG (Electronic Programme Guide)	35	and USB issues	62
Multimedia Browser	37	Annex 4 - Issues referring to connected	
Teletext	40	peripherals with a HDMI connector	63
		Index	64
		Recycling	65
		Product information	65

General

Do not insert the power plug in a wall socket or hang the TV to the wall before all connections are made.

- Place or hang the TV wherever you want, but make sure that air can circulate freely through the ventilation slots.

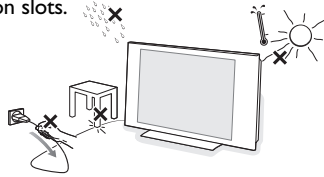

- Do not install the TV in a confined space such as a book case or a similar unit.
- To prevent any unsafe situations, no naked flame sources, such as lighted candles, should be placed in the vicinity.
- Avoid heat, direct sunlight and exposure to rain or water.
- The equipment shall not be exposed to dripping or splashing.

Care of the screen

Do not touch, push or rub or strike the screen with anything hard as this may scratch, mar or damage the screen permanently.

And please do not rub with dust clothes with chemical treatment.

Do not touch the surface with bare hands or greasy cloth (some cosmetics are detrimental to the screen). Unplug the TV before cleaning the screen.

When the surface becomes dusty, please wipe gently with absorbent cotton or other soft materials like chamois soaks. Do not use acetone, toluene and alcohol because they cause chemical damage. Do not use liquid cleaners or aerosol cleaners. Wipe off saliva or water drops as soon as possible. Their long time contact with the screen causes deformations and colour fading.

Stationary images on the TV screen

A characteristic of LCD and Plasma Panels is that displaying the same image for a long time can cause a permanent after-image to remain on the screen. Normal use of the TV should involve the showing of pictures that contain constantly moving and changing images that fill the screen.

Examples of stationary images (this is not an all-inclusive list, you may encounter others in your viewing):

- TV and DVD menus: listings of DVD disk content;
- Black bars: when black bars appear at the left and right side of the screen, it is recommended to change to a picture format so that the picture fills the entire screen;

- TV channel logo: present a problem if they are bright and stationary. Moving or low-contrast graphics are less likely to cause uneven aging of the screen;
- Stock market stickers: presented at the bottom of the TV screen;
- Shopping channel logos and pricing displays: bright and shown constantly or repeatedly in the same location on the TV screen. Examples of still pictures also include logos, computer images, time display, teletext and images displayed in 4:3 mode, static images or characters, etc.

Tip: reduce contrast and brightness when viewing.

Carefully pay attention to these remarks. The warranty does not apply to damage caused by not taking into account the above mentioned warnings on stationary images.

Electric, Magnetic and Electromagnetic Fields ("EMF")

- Philips Royal Electronics manufactures and sells many products targeted at consumers, which, like any electronic apparatus, in general have the ability to emit and receive electromagnetic signals.
- One of Philips' leading Business Principles is to take all necessary health and safety measures for our products, to comply with all applicable legal requirements and to stay well within the EMF standards applicable at the time of producing the products.
- Philips is committed to develop, produce and market products that cause no adverse health effects.
- Philips confirms that if its products are handled properly for their intended use, they are safe to use according to scientific evidence available today.
- Philips plays an active role in the development of international EMF and safety standards, enabling Philips to anticipate further developments in standardisation for early integration in its products.

Pixel characteristics

Your TV display is made with high-precision technology with a high number of colour pixels. Although it has effective pixels of 99,999% or more, black dots or bright points of light (red, green or blue) may appear constantly on the screen. This is a structural property of the display (within common industry standards) and is not a malfunction.

Before you start

Warning: do not insert the mains cord into the mains at the bottom of the TV and in a wall socket or hang the TV on the wall before all connections are made.

Before you switch on your TV, connect all your peripheral equipment. See To make video and audio connections, p. 43.

Overview of the rear connector panel

There is a wide range of audio and video equipment that can be connected to your TV. See To make audio and video connections, p. 43.

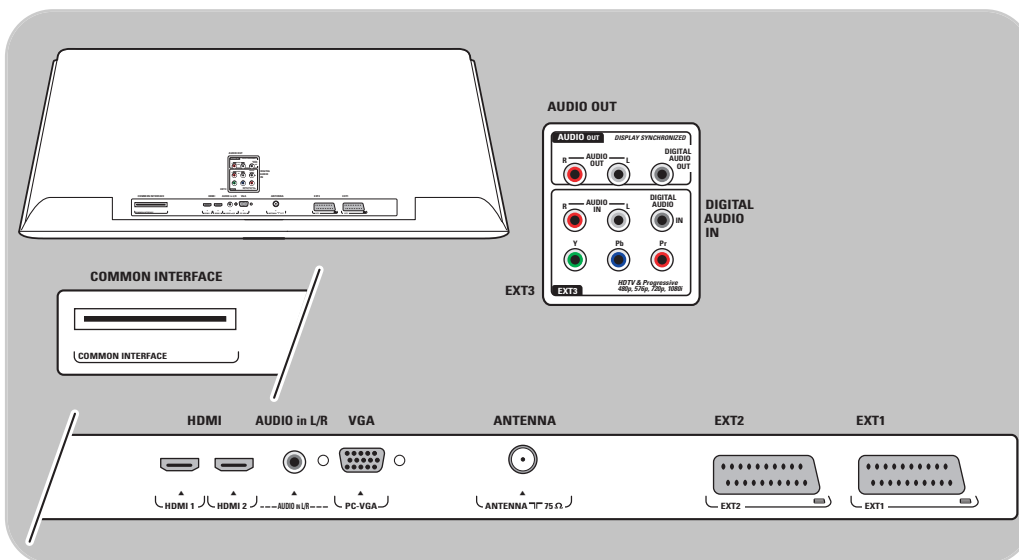

EXT1 can handle CVBS, RGB and Audio L/R;

EXT2 can handle CVBS, S-VIDEO, RGB, Audio L/R;

EXT3 can handle YPbPr and Audio L/R;

HDMI 1 and **2**.

VGA can handle VGA, SVGA and 480p, 576p, 1080i, Audio L/R.

Supported video formats: 480i, 480p, 576i, 576p, 720p, 1080i.

Warning: disconnect all power sources before making any connections.

Tip: it is preferable to connect peripherals with RGB output to **EXT1** or **EXT2** as RGB provides a better picture quality.

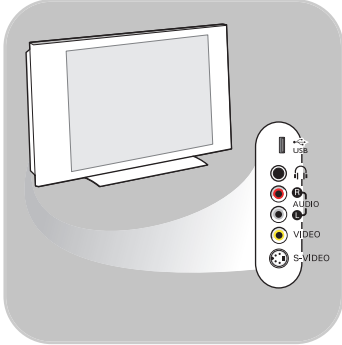

Overview of the side connector panel

- To connect a camera, camcorder or game, see To make video and audio connections, p. 44.
- To connect a headphone, see To make video and audio connections, p. 44.
- To connect a USB device, see Multimedia browser, p. 37.

Connect the antenna

- Insert the aerial plug firmly into the aerial socket  at the bottom of the TV.

Tip: for best quality use the suppressor cable supplied.

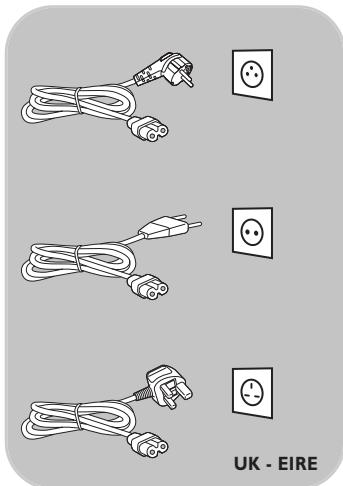

Connect the mains

- Insert the mains cord supplied into the mains at the bottom of the TV and in the wall socket.

Warning: verify that the mains supply voltage corresponds to the voltage printed on the sticker at the rear of the TV.

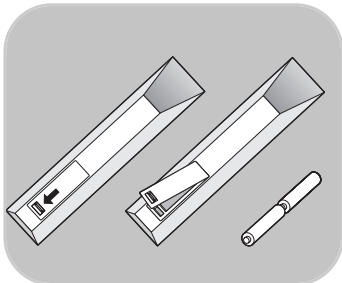

Remote control

- Insert the 2 batteries supplied (Type R6-1,5V). Be sure the (+) and (-) ends of the batteries line up correctly (inside of case is marked.)

For most keys pressing a key once will activate the function. Pressing a second time will de-activate it.



Standby

Press to switch the TV from or to standby mode.
When switched to standby, a red indicator on the TV lights up.

Attention: the TV is never powered off completely unless it is physically unplugged.

TV Press to select TV mode.

DVD STB VCR AUX

Press one of these keys to set your remote control to operate a peripheral device.
See Audio and Video equipment keys, p. 54.

DEMO Press to switch the Demo menu on or off.

Colour keys

- When functions are attached to the colour keys, the colour keys are shown on screen.
- To select a page in Teletext mode.

OPTION

- To open and close the Quick access menu which contains a few frequently used options, like Picture format.
- When in teletext, press repeatedly to enlarge the teletext page display. See Teletext, p. 41.

 To open and close the Electronic Programme Guide.
See EPG (Electronic Programme Guide), p. 35.

Cursor keys

Press the cursor keys up/down, left/right to navigate through the menus.

OK - To activate a setting

- Starts playing content in the Multimedia Browser application.

BROWSE/MENU:

To open and close the main menu. See How to navigate through the menus, p. 11.

Teletext On/Off

Press to switch teletext on. See Teletext, p. 40.
Only for UK: Digital text/Interactive services.

Attention: not all channels transmit interactive television applications at all times.

Volume

Press + or - to adjust the volume.

 **Mute key:** interrupt the sound or restore it.

**+P- Channel selection**

- to browse through the TV channels and sources stored and marked in the Favourite channels lists;
- to select a page in Teletext mode;
- to quickly browse through the lists in the menus;
- to switch the TV on from standby mode.

0/9 Digit keys

To select a TV channel between 0 and 999.

AV Select your peripherals

See Installation menu, Select your connections, p. 32.

P+P Previous channel

Press to alternate between the currently viewed and the previously viewed TV channel.

Ambilight-MODE

Ambilight: Press to switch Ambilight On or Off. For the Ambilight settings, see Use of the TV menu settings, Enjoy Ambilight, p. 20.

MODE: Press this key repeatedly to toggle through the Ambilight modes.

Note: when the TV is switched to standby, and you switch Ambilight On, Ambilight will be active. Only then less modes are available.

◀ ■ ▶ ►► Audio and Video equipment keys

See Audio and Video equipment keys, p. 54.

See Multimedia browser functional keys, p. 39.

■ CANCEL

Only for UK: Digital text/Interactive services.

Press this key to cancel those special services (and the function bar at the bottom of the screen).

● no function**i+ On screen information**

Press to display (when available) information about the selected TV channel and programme.

12 Dual screen

Press the **12** key to show teletext on the right of the screen.

FAV To display the channels list.

You can create up to four favourite lists.

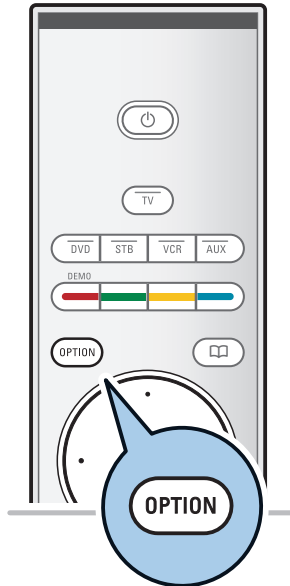

Quick access
Digital audio language
Digital subtitle language
Subtitles
Picture format
Equalizer
Clock

The **OPTION** key allows you to display the Quick access menu which will give you direct access to some features and menu options.

1. Press the **OPTION** key.
 - The Quick access menu appears.
2. Press the cursor up/down to select a menu item.
3. Press the **OK** key to jump to the selected menu item in the TV menu. (Except for the Clock option).
4. Use the cursor keys to make a selection.
5. Press the **OPTION** key to exit.

Note: digital related menu items will only be accessible in case of digital TV broadcasting.

Digital audio language:

See Adjust sound menu settings, p. 18.

Digital subtitle language:

See Adjust feature menu settings, p. 23.

Subtitles:

See Adjust feature menu settings, p. 23.

Picture format:

See Use of the TV menu settings, Adjust picture menu settings, p. 17.

Equalizer:

See Use of the TV menu settings, Adjust sound menu settings, p. 18.

Clock:

- Select to activate/deactivate the clock display on the screen.

Keys at the right side of the TV

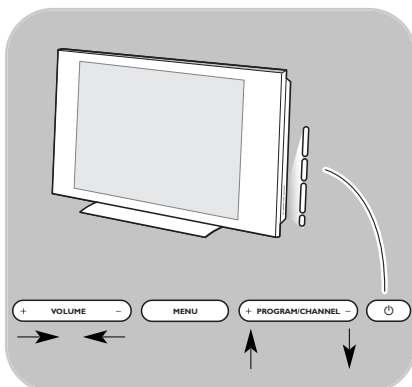

In case your remote is lost or broken, apart from channel selection and volume adjustment, you can still change some of the basic settings with the keys at the side of your TV.

- Press the power switch to switch the TV on or off.



The **MENU** key can be used to summon the TV menu without the remote control.

- Use the **VOLUME** - and + keys and the **PROGRAM/CHANNEL** - and + keys to select menu items.

Besides traditional analogue broadcasts, you can also receive digital broadcasts via a roof or loft mounted digital antenna in countries where those signals are available and which are supported by this TV. Verify if the country you are now located and you have selected during the installations (see further), supports digital video broadcasting via antenna. See www.philips.com/support for the list of supported countries or consult your local dealer or see the sticker at the back of your TV.

Note: for digital TV channels via a cable connection, you will need an extra set top box decoder; for digital TV channel via satellite, a satellite tuner and dish mounted outdoors are required. Also certain internet providers offer digital TV channels via broadband internet and a settop box.

Switch the TV on

- Press the power switch  at the side of the TV.
 - ▷ An indicator on the front of the TV lights up and the screen comes on.
- If the TV is in standby mode, press the **-P+** keys or the  key on the remote control.

Note: the first time (and only the first time) you switch on your TV, you see a Welcome screen followed by the installation procedure. See First time installation, p. 9.

First time installation

The installation procedure consists of a series of screens that will guide you through the installation of your TV. Follow the instructions on screen.

Note: if the TV has already been installed before and/or you want to change the First time installation settings, proceed with Use of the TV menu settings, p. 13.



Step 1: select your on-screen language

After the Welcome screen you are asked to select a language of the TV's on-screen menus. The text of the header and the info on screen continuously change language. Also the digital audio and subtitle language will be set to the selected menu language.

1. Press the cursor up/down to highlight your language.
2. Press the **OK** key on the remote control.
3. Follow the instructions on screen to proceed.

Step 2: complete the initial TV installation procedure

1. Press the green colour key on your remote control when **Television** is highlighted.
2. Select the country where you are now located.

Notes:

- if you select a wrong country, the channel numbering will not be according to the standard for your country.
- in case the country selected is not DVB-T supported by your TV, digital related menu-items will not be accessible.

3. Press the green colour key on your remote control to start the Automatic channel installation.
 - ▷ All available digital TV and radio channels and analogue TV channels are searched for and stored automatically. This will take a few minutes. When the search is complete, the menu will indicate the number of digital and analogue channels found.

Notes:

- reception of digital terrestrial TV channels is applicable dependent on the country selected;
- if you choose to install the channels at a later time, select the Automatic installation in the TV menu, Installation, Channels to scan available channels.

4. Press the red colour key again when the search is completed.

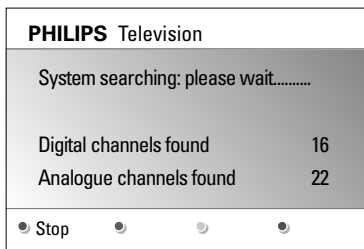
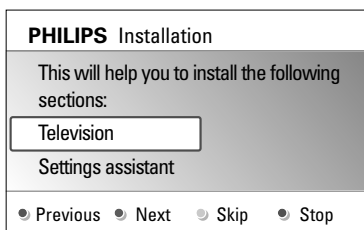
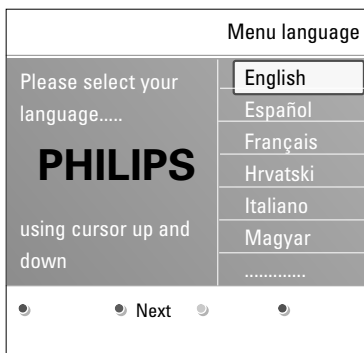

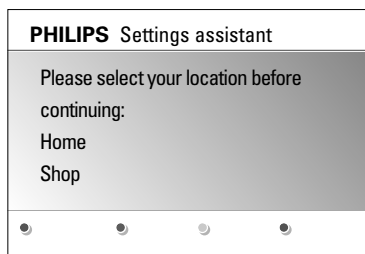
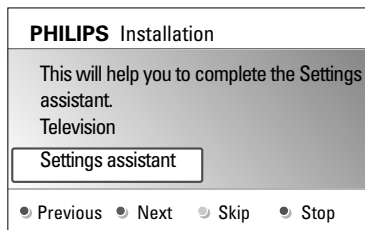

Step 3: Settings assistant: select your TV settings

By means of several split screens/full screens you are prompted to select your preferred picture, sound and ambilight settings, to finally arrive at a complete setting which satisfies you.

1. Press the green colour key on your remote control to enter the **Settings assistant** menu.
2. Select your Location with the cursor up/down.
 - ▷ If you choose **Shop** it will skip the Settings assistant. The TV parameters for Picture, Sound and Ambilight will then be set to predefined fixed settings. Press the green colour key again to proceed.
 - ▷ If you choose **Home** it will display the Settings assistant.
3. Use the cursor left/right to each time select your preferred screen.
4. Press the green colour key to each time confirm your selection and to jump to the following screen.
 - ▷ The following items will be presented sequentially. In the header it is mentioned how many screens have been completed and how many screens there are in total.

The Settings assistant will step sequentially through the following settings: Picture, Sound and Ambilight.
5. Press the green colour key again to store all the settings and to return to the TV installation menu.

Note: when you skip or stop the Settings Assistant, then the standard settings Philips selected for you will be chosen.

6. Press the red colour key again to finish the First time installation procedure and to display the first stored TV channel.

Note: any time you can change or reset your settings or adjust individual settings for Picture, Sound and Ambilight in the TV settings menu. See p. 13, Use of the TV menu settings.
To control the settings of special TV functions, features and accessory equipment, see p. 23, Adjust feature menu settings.



Introduction

A lot of guiding instructions, help texts and messages will be displayed on your TV when you use the menus or when you try to execute an action.

Read the help texts which are being displayed on the specific item highlighted.

The colour keys at the bottom of the screen refer to the different actions which may be executed.

Press the corresponding colour key on the remote control to perform the required or desired action.

Note: digital related menu items will only be accessible in case of digital TV broadcasting.

1. Press the **MENU/BROWSE** key on the remote control.
 - The main menu appears on the screen.
 - **TV menu** allows you to access the TV menu. See below.
 - **TV channels** allows you to access the TV channel list and to create up to four favourite lists with your preferred TV channels and digital radio stations. See *Create your favourite channel list*, p. 34.
 - **Programme guide** allows you to access detailed information about individual digital TV programmes. According to the type of Electronic Programme Guide, it also allows you to access the table of scheduled Digital TV programmes and easily select and tune to a desired programme. See *EPG, Electronic Programme Guide*, p. 35.
 - **Multimedia** allows you to access the Multimedia browser application. It lets you display your personal multimedia files. Multimedia is only present when a USB device is connected. See *Multimedia browser*, p. 37.
2. Use the cursor up/down to highlight and select a menu item.
3. Use the cursor right to enter the highlighted menu item.
 - The right panel shows the content of the highlighted menu item.

Television	TV menu
	TV channels
	Programme guide
Multimedia	

TV menu	TV settings
TV settings	Settings assistant
Features	Reset to standard
Installation	Picture
	Sound
	Ambilight
Info	

TV menu	TV settings
TV settings	Settings assistant
Features	Reset to standard
Installation	Picture
	Sound
	Ambilight
Info	

4. Use the cursor up/down to select a menu item.
 - **TV settings** allows you to adjust your preferred picture, sound and ambilight settings
 - **Features** allows you to control the settings of special TV features
 - **Installation** allows you
 - to select your language preferences;
 - to search for and store your TV channels;
 - to set or adjust various special functions;
 - to select connected peripheral equipment;
 - to define one or more channel numbers as decoder channel numbers;
 - to reset your picture, sound and ambilight settings to the factory standard settings;
 - to upgrade your TV software
5. Press the cursor right to enter the highlighted menu item.
 - ▷ The content of the right panel is moved to the left panel and the right panel now shows the content of the newly highlighted item in the left panel.

Note: in some cases it is important that the picture can be watched while you adjust the settings. This means that when the highlight is on the right side panel, the other menu items hide away. When the cursor left is pressed, the hidden menu items reappear and the highlight moves to the left panel.

6. Press the **MENU/BROWSE** key to exit the main menu.

Television	TV menu
	TV channels
	Programme guide
Multimedia	

The TV menu allows you to access and change settings and preferences in case you want to change the First time installation settings and/or you want to control the settings of special TV functions, features and peripheral equipment.

Adjust viewing and listening settings

TV menu	TV settings
TV settings	Settings assistant
Features	Reset to standard
Installation	Picture
	Sound
	Ambilight
Info	

1. Press the **MENU/BROWSE** key on the remote control.
 - The main menu appears on the screen.
2. Select **TV menu** and press the cursor right.
 - The TV menu is displayed.
3. Select **TV settings** and press the cursor right.
 - The TV settings menu is moved to the left.
4. Press the **MENU/BROWSE** key to exit the menu.

To make it easier to change the settings of the TV, there are 3 ways of doing it.

A. Change settings in an easy-to-use manner with the Settings assistant

Each time you've made a selection, press the green key to confirm your selection.

1. Select **Settings assistant** and press the cursor right.
 - By means of several split screens/full screens you are prompted to select your preferred picture, sound and ambilight settings to finally arrive at a complete setting which satisfies you.
 - See First time installation, Step 3: Settings assistant: select your TV settings, p. 10.
2. Press the green colour key to return to the TV menu again.

TV menu	
TV settings	Reset to standard
Settings assistant	Current
Reset to standard	Natural
Picture	Vivid
Sound	Subtle
Ambilight	
Info	

B. Use of the Standard settings (if present)

This allows you to reset your settings for viewing and listening to predefined factory settings.

1. Select **Reset to standard** and press the cursor right.
 - ▷ A menu appears which allows you to select one of the standard settings for viewing and listening.
 - ▷ **Current** shows your current settings for viewing and listening.
 - ▷ If you select **Natural**, it allows you to set your picture, sound and ambilight settings to the recommended standard values. In most cases this will give the best balanced viewing experience.
 - ▷ If you select **Vivid**, it allows you to set your picture, sound and ambilight settings to rich values, making use of the TV capabilities to its full extend.
 - ▷ If you select **Subtle**, it allows you to set your picture, sound and ambilight settings to the purest representation of the original source content.
2. Press the green colour key to store the selected setting.

C. Individual settings for picture, sound and ambilight

- Select **Picture**, **Sound** or **Ambilight** and press the cursor right.
 - ▷ A menu appears which allows you to fine tune the picture, sound and ambilight settings.
 - ▷ To adjust the Picture settings, see Adjust picture menu settings, p. 15.
 - ▷ To adjust the Sound settings, see Adjust sound menu settings, p. 18.
 - ▷ To adjust the Ambilight settings, see Enjoy Ambilight, p. 20.

TV menu	TV settings
TV settings	Settings assistant
Features	Reset to standard
Installation	Picture
	Sound
	Ambilight
Info	

The picture menu contains the settings that affect the quality of the picture.

1. Press the **MENU/BROWSE** key on the remote control.
 - ▷ The main menu appears.
2. Select **TV menu** and press the cursor right.
 - ▷ The TV menu is moved to the left.
3. Select **TV settings** and press the cursor right.
 - ▷ The TV settings menu is moved to the left panel.
4. Select **Picture** and press the cursor right.
 - ▷ The Picture menu is moved to the left panel.
5. Use the cursor up/down to select the Picture menu items.
6. Press the cursor right to enter the selected Picture menu item.

Note: all digital related menu items will only be accessible in case of digital TV broadcasting.

TV menu	Picture
TV settings	Picture
Settings assistant	Contrast
Reset to standard	Brightness
Picture	Colour
Sound	Hue
Ambilight	Sharpness
	Tint

Info	

7. Use the cursor keys to adjust the settings.
8. Press the cursor left to return to the Picture menu.

Contrast

Adjusts the intensity of bright parts in the picture but keep the dark parts unchanged.

Brightness

Adjusts the light output of the complete picture, which will mainly affect the darker areas of the picture.

Colour

Adjusts the saturation level of the colours to suit your personal preference.

Hue

Compensates for the colour variations in NTSC encoded transmissions.

Sharpness

Adjusts the sharpness of fine details in the picture.

Tint

Increases or decreases **Warm** (red) and **Cool** (blue) colours to suit personal preferences.

- Select **Cool** to give the white colours a blue, **Normal** to give the white colours a neutral, **Warm** to give the white colours a red tint.
- Select **Custom** to make a customised setting in the Custom tint menu item.

TV menu	
TV settings	Picture
Settings assistant
Reset to standard	Custom tint
Picture	Pixel Plus
Sound	Digital Natural Mo..
Ambilight	Dynamic contrast
	DNR

Info	

Custom tint (only when Tint is set to Custom)

Fine tunes the white point (**WP**) and black level (**BL**) of the picture.

1. Select **Custom tint** and press the cursor right.
2. Use the cursor keys to select and adjust the settings of:
 - R-WP**: allows you to customise the colour tint by adjusting the red whitepoint of the picture.
 - G-WP**: allows you to customise the colour tint by adjusting the green whitepoint of the picture.
 - B-WP**: allows you to customise the colour tint by adjusting the blue whitepoint of the picture.
 - R-BL**: allows you to customise the colour tint by adjusting the red blacklevel of the picture.
 - G-BL**: allows you to customise the colour tint by adjusting the green blacklevel of the picture.
3. Use the colour keys to reset to the predefined settings.
4. Press the cursor left to return to the Picture menu.

Pixel Plus

Pixel Plus is the most ideal setting, as it fully processes the image to make every single pixel the best it can be, improving contrast, sharpness, picture depth, and colour reproduction and brilliance from every source, including High Definition.

- o Select **On** or **Off** to activate/de-activate Pixel Plus.

Digital Natural Motion

Reduces the field and line flicker and reproduces smooth movement especially in movies.

- o Select **Off**, **Minimum** or **Maximum** in order to really see the difference in picture quality.

Dynamic contrast

Automatically makes the contrast in the darker and the brighter picture areas more noticeable as the image on the screen changes.

- o Normally select **Medium**. It may be preferred to select **Minimum**, **Maximum** or **Off**.

DNR

DNR automatically filters out and reduces the image noise. This improves picture quality when receiving weak signals.

- o Select **Off**, **Minimum**, **Medium** or **Maximum** according to the image noise in the picture.

TV menu	
TV settings	Picture
Settings assistant
Reset to standard	DNR
Picture	MPEG artefact red.
Sound	Colour enhancem..
Ambilight	Active control
	Light sensor
	Picture format
Info	

MPEG artefact reduction

MPEG artefact reduction On smoothens the transitions on digital content.

- Select **On** or **Off**.

Colour enhancement

Automatically controls green enhancement and blue stretch. It makes the colours more vivid.

- Select **Off**, **Minimum**, **Medium** or **Maximum**.

Active control

The TV continuously measures and corrects all incoming signals in order to provide the best picture possible.

- Select **On** or **Off** to activate/de-activate Active control.

Light sensor

Light sensor **On** automatically adjusts the picture and ambilight settings for best viewing dependent on the lighting conditions in the room.

- Select **On** or **Off**.

Picture format

This allows you to adjust the size of the picture dependant on the broadcasted format and your preferred setting.

Tip: this function is also accessible via the **OPTION** key on the remote control.

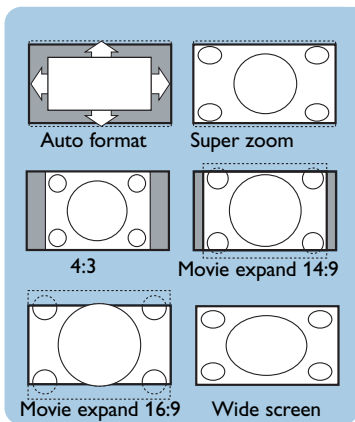

How to navigate through the TV settings menu, see p. 12: Use of the TV menu settings.

Choose among the following picture formats: Auto format, Super zoom, 4:3, Movie Expand 14:9, Movie Expand 16:9 or Wide screen.

Auto format makes the picture fill the screen as much as possible.

In case of subtitles in the bottom black bar; Auto format makes the subtitles visible.

In case of a broadcaster logo in the corner of the top black bar; the logo disappears from the screen.

Super zoom removes the black bars on the sides of 4:3 programmes with minimal distortion.

When in Movie Expand 14:9, Movie Expand 16:9 or Super zoom screen format, you can make subtitles visible with the cursor up/down.

Note: with HD sources not all picture formats will be available.

TV menu	
TV settings	Sound
Settings assistant	Equalizer
Reset to standard	Volume
Picture	Balance
Sound	Digital audio lang..
Ambilight	Dual I/II
	Mono/Stereo

Info	



Manufactured under license from Dolby Laboratories. 'Dolby' 'Pro Logic' and the double-D symbol are trademarks of Dolby Laboratories.

The sound menu contains the settings that affect the quality of the sound.

1. Press the **MENU/BROWSE** key on the remote control.
 - ▷ The main menu appears.
2. Select **TV menu** and press the cursor right.
 - ▷ The TV Menu is moved to the left.
3. Select **TV settings** and press the cursor right.
 - ▷ The TV settings menu is moved to the left panel.
4. Select **Sound** and press the cursor right.
 - ▷ The Sound menu is moved to the left panel.
5. Use the cursor up/down to select the Sound menu items.
6. Press the cursor right to enter the selected Sound menu item.

Note: dependent on the input signal, one or more menu items may not be selectable.

7. Use the cursor keys to adjust the settings.
8. Press the cursor left to return to the Sound menu.

Equalizer

Allows you to change the frequency response of the sound to match your personal taste.

Tip: this function is also accessible via the **OPTION** key on the remote control.

Volume

Allows you to adjust the sound output level.

Balance

Allows you to adjust the output of the right and left speakers to obtain the best stereo reproduction for your listening position.

Digital audio language (only with Digital TV broadcasting)

Allows you to select an audio language out of the list of the available broadcasted languages for the current digital programme.

Note: if there is more than one variant for an audio language, then select one of the variants.
To permanently change the audio language, use the Language menu in the Installation menu.

Tip: this function is also accessible via the **OPTION** key on the remote control.

TV menu	
TV settings	Sound
Settings assistant
Reset to standard	Mono/Stereo
Picture	Surround mode
Sound	Headphone volume
Ambilight	AVL
	Delta volume
	Auto surround
Info	

Dual I/II

Allows you to select, per channel, **Dual I** or **II**, when dual sound transmission is available.

Mono/Stereo

Allows you to select, per TV channel, **Mono** or **Stereo** sound when stereo broadcasts are available.

Surround mode

Allows you to select the modes for more spatial or surround sound reproduction dependent on the broadcasted signals or signals from external inputs received.

Headphone volume

Allows you to control the level of sound through the headphones.

AVL (Automatic Volume Leveler)

Automatically reduces the volume differences between channels and programmes, providing a more constant overall level. This will also reduce the dynamics of sound.

Delta volume

Allows you to correct for any permanent volume differences between TV channels or external sources.

Auto surround

When switched **On**, this allows the TV to automatically switch to the best surround sound mode the broadcaster transmits.

TV menu	
TV settings	Ambilight
Settings assistant	Ambilight
Reset to standard	Brightness
Picture	Mode
Sound	Colour
Ambilight	Custom colour
	Separation

Info	

The ambilight menu contains the settings for controlling the ambient lighting. Using ambient light gives a more relaxed viewing experience and improves perceived picture quality. Analysis of the picture content adapts the colours continuously. But the lights can also be set to any fixed colour and many shades of white.

Tip: in standby mode the lights can be set/operated to any colour and create a unique ambiance in the room. See Ambilight in standby mode, p. 22.

1. Press the **MENU/BROWSE** key on the remote control.
 - ▷ The main menu appears.
2. Select **TV menu** and press the cursor right.
 - ▷ The TV Menu is moved to the left.
3. Select **TV settings** and press the cursor right.
 - ▷ The TV settings menu is moved to the left panel.
4. Select **Ambilight** and press the cursor right.
 - ▷ The Ambilight menu is moved to the left panel.
5. Use the cursor up/down to select the Ambilight menu items.
6. Press the cursor right to enter the selected Ambilight menu item.
7. Use the cursor keys to adjust the settings.
8. Press the cursor left to return to the Ambilight menu.

Ambilight

Allows you to switch the lights On or Off at the rear of the TV.

- Select **Off** to switch off the ambient lights and downlight all other ambilight menu items.
- Select **On** to switch on the ambient lights. Refine the light settings in the menus below.

Brightness

Allows you to adjust the light output of the ambilights.

TV menu	
TV settings	Ambilight
Settings assistant
Reset to standard	Mode
Picture	Colour
Sound	Custom colour
Ambilight	Separation
	Balance
Info	

Mode

Allows you to choose for constant background lighting or for background lighting that matches the images displayed on the screen.

- o Use the cursor keys to select Colour, Relaxed, Moderate or Dynamic.
 - **Colour**: this will show constant light according to the settings in the Colour menu below. It allows manual fine tuning in the next Ambilight menu items.
 - The options **Relaxed**, **Moderate** or **Dynamic** will dynamically match brightness and colour to the screen content. The selection made will effect the speed which determines the viewing impression.
For example:
 - in **Relaxed** mode, the rate of brightness and colour change, as predefined in the factory, is smoothly and soft which gives you an immersive yet relaxed viewing.
 - in **Moderate** mode the rate of brightness and colour change can be experienced as between Relaxed and Dynamic.
 - in **Dynamic** mode the rate of brightness and colour change is more quick and dynamic. This gives you full immersion and involvement with the screen content.

Notes:

- the rate of change is limited, as not to cause uncomfortable sensations;
- according to the selection made, some Ambilight menu items will be downlighted and can not be selected.

Colour

Note: only available when Colour has been selected in the Mode menu above.

Allows you to select or adjust the colour of the light to your own personal choice.

- **Warm white** is matched to that of most normal lightbulbs. Select this setting if you want the Ambilight to fit best with normal living room lighting.
- **Cool white** is matched to that of normal daylight (6500K). Select this setting if you prefer more cool lighting.

Note: the 6500K is the SMPTE recommended setting for ambient backlighting of displays.

- **Blue**: preferred by most consumers to create a cool, modern and/or mystical atmosphere. Select this setting according to your personal taste or mood.
- **Red**: preferred by most consumers to create a cosy, special atmosphere. Select according to your personal taste or mood.
- **Custom**: select if you want to customise the ambilight colour.

TV menu	
TV settings	Ambilight
Settings assistant
Reset to standard	Mode
Picture	Colour
Sound	Custom colour
Ambilight	Separation
	Balance
Info	

Custom colour

Note: only available when Custom has been selected in the Colour menu.

Allows you to customise the ambilight colour.

- Select **Palette** to select the general colour of the light output.
- Select **Saturation** to adjust the colourfulness of the light.

Separation

Allows you to define the stereo effect in case, Relaxed, Moderate or Dynamic has been selected in the Mode menu.

- Select **Off** for a mono behaviour which means that all lamps will behave equally.
- Select **Minimum**, **Medium** or **Maximum** to define the Ambilight stereo effect spread over the available lamps.

Balance

Allows you to adjust the colour and level of light intensity on the left and right side of the picture.

Ambilight in standby mode

When the TV is switched off, the ambient lights will also be switched off. When the TV is in standby mode, ambilight can be used to provide a unique ambience for the room.

- Press the **Ambilight** key on the remote control to switch between Ambilight On or Off. See Use of the remote control, p. 6.
- Press the **MODE** key repeatedly to toggle through the Ambilight modes.

Note: when the TV is switched to standby, and you switch Ambilight On, then less Ambilight modes are available.

Caution: Infrared interference

To avoid bad infrared remote control reception, place your peripheral equipment out of sight of the ambient lights of your TV. Ambilight does not function well when the room temperature is less than 59°F/15°C.

TV menu	Features
TV settings	Subtitle
Features	Digital subtitle lan..
Installation	Sleeptimer
	Childlock
	Set/Change code
	On timer

Info	

The Features menu allows you to control the settings of special TV functions, features and accessory equipments.

1. Press the **MENU/BROWSE** key on the remote control.
 - The main menu appears.
2. Select **TV menu** and press the cursor right.
 - The TV Menu is moved to the left.
3. Select **Features** and press the cursor right.
 - The Features menu is moved to the left panel.
4. Use the cursor up/down to select the Features menu items.
5. Press the cursor right to enter the selected Features menu item.
6. Use the cursor keys to adjust the settings.
7. Press the cursor left to return to the Features menu.

Subtitle

This displays Teletext and DVB-T subtitles from the selected TV channel. These can be permanently displayed, or only when mute is active. The teletext subtitle page of analogue channels must be stored for each TV channel.

1. Switch on teletext and select the proper subtitle page from the index.
2. Switch off teletext.
3. Select
 - **Subtitle On** to display the subtitles on the selected TV channels.
 - **On during mute** to automatically display the subtitles only when the sound has been muted with the **MUTE** key on the remote control.

Tip: this function is also accessible via the **OPTION** key on the remote control.

Digital subtitle language (only with Digital TV broadcasting)

This allows you to (temporarily) select your preferred subtitle language out of the list of the broadcasted languages for the current programme.

Note: to permanently change the subtitle languages, use the Language menu in the Installation menu.

- Use the cursor up/down to temporarily overrule your permanent language selection and confirm with the **OK** key.

Tip: this function is also accessible via the **OPTION** key on the remote control.

TV menu	Features
TV settings
Features	Sleeptimer
Installation	Childlock
	Set/Change code
	On timer
	Common interface
	Demo
Info	

Sleeptimer

This sets a time period after which the TV automatically switches to standby.

1. Select **Sleeptimer**.
2. Press the cursor right.
3. Select a value with the cursor up/down.
 - ▷ The list will have values from 0 to 180 minutes. When 0 is selected, the sleeptimer is switched off.

Note: you can always switch off your TV earlier or select another time set.

Childlock

With a 4-digit code, you are able to lock TV channels and external sources to prevent children from watching certain programmes.

1. Select **Childlock**.
2. Press the cursor right to enter the Childlock menu.
3. Enter your 4-digit code.

Note: you have to re-enter your code each time you enter the Childlock menu.
4. Select one of the menu items of the Childlock menu and press the cursor right:
 - **Lock** to lock all channels and externals:
 - **Custom lock** to lock a certain programme or to lock all the channels from a certain time.
 - Select:
 - **Lock after** to lock all programmes from a certain time onwards.
 - Press the cursor right twice.
 - Select **On** to set the lock.
 - Press the cursor left.
 - Select **Time** and press the cursor right.
 - Enter the time with the cursor up/down and right.
 - **Channel lock** to lock a certain TV channel or external.
 - Press the **OK** key to activate/deactivate.
 - **Parental rating** to set an age rating to a digital programme if the programme is parental rated. The ratings applied are according the selected country in the initial installation.
 - Press the cursor right and select an age rating with the cursor up/down.
 - Select **Unlock** to disable all locks you have set.

Important: you have forgotten your code !

1. Select **Change code** and press the cursor right.
2. Enter the overriding code 8-8-8-8.
3. Enter a new personal 4-digit code.
4. Confirm your new entered code.
 - ▷ The previous code is erased and the new code is stored.

TV menu	Features
TV settings
Features	Sleeptimer
Installation	Childlock
	Set/Change code
	On timer
	Common interface
	Demo
Info	

Set code/Change code

This allows you to set or change the personal 4-digit access code that is used in the different lock functions of the TV.

- Select **Set** or **Change code**.
 - ▷ If no PIN-code exists yet, the menu item is set to **Set code**. Follow the instructions on screen.
 - ▷ If a PIN-code has previously been entered, the menu item is set to **Change code**. Follow the instructions on screen.
- Enter your code with the digit keys. All number combinations from 0000 to 9999 are valid numbers.
 - ▷ The Features menu reappears with a message confirming that your PIN-code has been created or changed.

On timer

From standby, this automatically switches the TV to the specified channel number, at a specified time.

1. Select **On timer**.
2. Press the cursor right to enter the On timer menu.
3. Select **Timer** and press the cursor right.
4. Select **On**.
5. Select **Channel** and then the TV channel you want your TV to switch to on a selected time and day
6. Select **Day** and then a day of the week or select **Daily**.
7. Select **Time** and enter the time with the digit keys or with the cursor up/down.
8. Press the **OK** key to activate.
9. Press the cursor left to return to the Features menu or press the **MENU/BROWSE** key to switch off the menu.

Note: From now on, **every week**, your TV will automatically switch to the selected channel, on the selected day, at the selected time, until the On timer function is switched off again.

Note: only one On timer can be set.

TV menu	Features
TV settings
Features	Sleeptimer
Installation	Childlock
	Set/Change code
	On timer
	Common interface
	Demo
Info	

Common interface

Note: this functionality is only available in certain countries.

This allows you to access common interface applications defined by the service provider of the Common Interface (CI) module.

The Common Interface (CI) module can contain one or more applications, which are used to communicate with the CI service provider and provide some additional facilities to the user.

See Use the Common Interface slot, p. 52.

Note: this menu item and the common interface applications are only selectable when an authenticated Common Interface card is present and some Common Interface card user interface sessions are listed. The CI service provider is responsible for the messages and texts on screen. In case of failure or strange behaviour, you must call your CI service provider.

TV menu	
Features	Demo
Subtitle	Pixel Plus
Dig. subtitle langu.	Ambilight
Sleeptimer	Settings assistant
Childlock	Active control
Set/Change code	
On timer	
Common interface	
Demo	
Info	

Demo

This allows you to get an idea of the features that are part of the television.

1. Select **Demo**.
2. Press the cursor right.
3. Select a desired demo.
4. Press the **OK** key to start the demo.
 - ▷ The selected demo is played once.
5. Press the red colour key to stop the demo and to return to the demo menu.
6. Press the red colour key to exit the demo menu.

Tip: you will need this chapter only if you want to change the installation settings.

Television	TV menu
	TV channels
	Programme guide
Multimedia	

TV menu	Installation
TV settings	Languages
Features	Country
Installation	Time zone
	Channels
	Preferences
	Connections

Info	

Installation menu

This menu will adjust settings related to the installation of the TV channels, language and country and to the initial installation of your TV.

1. Press the **MENU/BROWSE** key on the remote control.
 - The main menu appears.
2. Select **TV menu** and press the cursor right.
 - The TV Menu is moved to the left.
3. Select **Installation** and press the cursor right.
 - The Installation menu is moved to the left panel.
4. Use the cursor up/down to select the Installation menu items.
5. Press the cursor right to enter the selected Installation menu item.
6. Use the cursor keys to make a selection.
7. Press the **OK** key to activate or to confirm.
8. Press the cursor left to return to the Installation menu or press the **MENU/BROWSE** key to switch off the menu.

Select your language preferences

This menu allows you to select your preferred language for menu, audio and subtitle.

TV menu	
Installation	Languages
Languages	Menu language
Country	Preferred audio l...
Time zone	Preferred subtitle...
Channels	Hearing impaired
Preferences	
Connections	
Decoder	
.....	
Info	

Menu language

This allows you to select your menu language out of the list of the available languages.

Preferred audio language (only with Digital TV broadcasting)

This allows you to select your audio language preference in case several languages are broadcasted.

Preferred subtitle language (only with Digital TV broadcasting)

This allows you to select your subtitle language preference in case several languages are broadcasted.

Hearing impaired (only with Digital TV broadcasting)

This allows you to select the hearing impaired audio or subtitle language.

When set to **On**, the Hearing impaired version of your preferred audio or subtitle language will, if available, be reproduced.

When set to **Off**, the normal audio and subtitle language behaviour will be applicable.

TV menu	Installation
TV settings	Languages
Features	Country
Installation	Time zone
	Channels
	Preferences
	Connections

Info	

Select your country

This allows you to select the country where you are now located.

Notes:

- if you select a wrong country, the channel numbering will not be according to the standard for your country;
- in case the country selected is not DVB-T supported by your TV, digital related menu-items will not be accessible.

Select the time zone (only with Digital TV broadcasting)

Only applicable for certain countries and dependent on the selected country.

This allows you to select your local time zone so that the clock display shows the correct time.

Store TV and radio channels

After language and country are set correctly, you can now search for and store the TV channels.

- o Select **Channels** in the TV, Installation menu.

Automatic installation

The TV will scan the entire frequency spectrum based on the selected country.

- ▷ All available digital and analogue TV and digital radio channels are searched for and stored automatically. This will take a few minutes.
- ▷ When the search is complete, the menu will indicate the number of digital and analogue channels found.

Installation update

This allows you to automatically tune to and update all available channels.

Notes:

- this will not reinstall uninstalled channels;
- new channels found will not be added to any favourite list;
- already installed channels will not be renumbered.

TV menu	
Installation	Channels
Languages	Autom. installation
Country	Installation update
Time zone	Digital: test recept..
Channels	Analogue: manual..
Preferences	Rearrange
Connections	
Decoder	
.....	
Info	

TV menu	
Installation	Channels
Languages	Autom. installation
Country	Installation update
Time zone	Digital: test recept..
Channels	Analogue: manual..
Preferences	Rearrange
Connections	
Decoder	
.....	
Info	

Digital: test reception (only with Digital TV broadcasting)

This allows you to see the quality and the strength of the signal reception for a digital frequency. This enables you to find the antenna position that gives the best reception.

- o Select **Digital: test reception** and press the cursor right.
 - ▷ You obtain an indication of the actual channel frequency, the network name, the signal quality and strength.
 - ▷ If the signal quality and strength is poor, you can try repositioning the aerial.

Tip: it is however advisable to contact a specialised aerial installer in order to achieve the best results. You can also directly enter the frequency of the digital channels you want to test.

TV menu/Installation	
Channels	Analogue: manual..
Automatic install...	System
Installation update	Search
Digital: test recept.	Fine tune
Analogue: manual..	Store current chan.
Rearrange	Store as new chan.
Info	

Analogue: manual installation

This gives you the possibility to manually install (tuning-in channel by channel) analogue channels. Manual installation will not find nor store any DVB-T (digital) channels.

1. Select **Analogue: manual installation** and press the cursor right.
2. Select **System**.
3. Select your country or part of the world where you are now located.
4. Select **Search** and press the cursor right.
5. Select the red or green colour key to proceed.

Tip: if you know the frequency, enter the 3 digits of the frequency with the digit keys 0 to 9 (For example, 049).

6. Press the cursor left to store the channel found or to search for another channel.
7. Select **Fine tune** and press the cursor right. Fine tuning can be useful when the frequency has shifted a bit or when interference of another frequency occurs. Adjust the frequency with the cursor up/down in case of poor reception of the channel found.
8. Select **Store current channel** if you want to store the (fine tuned) frequency under the current channel number. Press the cursor right and confirm with the **OK** key. Select **Store as new channel** if you want to store the (fine tuned) frequency under a new channel number. Press the cursor right and confirm with the **OK** key.
9. Use the rearrange menu to rename or reshuffle the channels. See next page.

Note: when on a frequency where a DVB signal is broadcasted, the tuner will try to decode an analogue TV channel, and hence will not show video.

TV menu	
Installation	Channels
Languages	Autom. installation
Country	Installation update
Time zone	Digital: test recept..
Channels	Analogue: manual..
Preferences	Rearrange
Connections	
Decoder	
.....	
Info	

TV menu/Installation	
Channels	Rearrange
Automatic instal...	0
Installation update	1
Digital: test rec....	2
Analogue: manual	3
Rearrange	4
	5
	6
	7
Info	

Rearrange	
0	
1	
2	
3	
4	
5	
6	
7	

<input type="radio"/> Rename	<input type="radio"/> Uninstall	<input type="radio"/> Move up	<input type="radio"/> Move down
------------------------------	---------------------------------	-------------------------------	---------------------------------

This allows you to rename, to reshuffle and to uninstall or reinstall the stored channels.

- Press the corresponding colour keys and follow the on screen instructions.

Reshuffle

This allows you to change the order of the stored TV channels.

- Select the channel you want to change place.
- Press the yellow colour key to move up a single position in the list.
- Press the blue colour key to move down a single position in the list.
- Repeat to reshuffle other TV channels.

Rename

This allows you to change the name stored in the memory or to assign a name to a channel or external for which a name has not yet been entered.

- Select the channel you want to rename.
- Press the red colour key on your remote control.
- Select the characters with the cursor up/down. Select the following position with the cursor right.
- Press the green colour key or the **OK** key when finished.

Notes:

- press the yellow colour key to delete all characters. The cursor is positioned at the beginning again;
- press the blue colour key to delete the character the cursor is positioned. Enter a new character with the cursor up/down;
- a name can be given to the channel numbers 0 to 999;
- space, numbers and other special characters are located between Z and A.

- Select another channel number and repeat steps 2 to 5.

Uninstall - reinstall

This allows you to uninstall a stored channel so that it is no longer possible to tune to. This also allows you to reinstall an earlier uninstalled channel.

- Select the channel you want to uninstall.
- Press the green colour key to uninstall the selected channel.
 - The uninstalled channel is indicated in the list by an icon in front of the uninstalled channel.
- Press the green colour key again to reinstall the uninstalled channel.

Note: uninstalled channels are not reinstalled during an installation update.

TV menu	
Installation	Preferences
.....	Location
Time zone	Teletext 2.5
Channels	OSD
Preferences	Programme title
Connections	
Decoder	
Factory settings	
Software upgrade	
Info	

This menu contains items that can set or adjust various special TV functions and that will typically be accessed only occasionally.

Select your location

This allows you to select the location of your TV.

If you choose for **Shop** it will result in fixed settings of picture, sound and ambilight.

The location **Home** will give full flexibility to change any predefined settings for picture, sound and ambilight.

Select Teletext 2.5

Some broadcasters offer the opportunity to see more colours, other background colours and nicer pictures in the teletext pages.

- Select **Teletext 2.5 On** to take advantage of this feature.
- Select **Teletext 2.5 Off** if you like the more neutral teletext layout.
 - ▷ The selection made is valid for all the channels which broadcast Teletext 2.5.

Note: it may take a few seconds before teletext broadcast switches over to Teletext 2.5.

Select the On Screen Display (OSD)

This allows you to select the display of the volume bar and a reduced or extended on screen display of programme and channel information.

- Select **Minimum** to activate the display of reduced channel information.
- Select **Normal** to activate the display of extended channel and programme information. For example, information on the programme, input signal quality of connected peripheral equipment, the screen format and sound mode, selected audio language, subtitle language, ratings, remaining time of the sleeptimer setting,...

Display a Programme title

This allows you, to display the programme title according to the transmitted information.

- ▷ When selected **Yes**, after the selection of a TV programme or after you press the **i+** key on the remote control, a programme title will be displayed if transmitted.

TV menu	
Installation	Connections
.....	EXT1
Time zone	EXT2
Channels	EXT3
Preferences	HDMI 1
Connections	HDMI 2
Decoder	VGA
Factory reset	Side
Software upgrade	AUDIO IN L/R
	DIGITAL AUDIO IN
Info	

This allows you to select the peripheral equipment you have connected to the audio and video connectors.

1. Select **Connections**.
2. Press the cursor right.
3. Select the input to which the peripheral equipment is connected.
 - ▷ When you select **EXT1, EXT2, EXT3, HDMI 1, HDMI 2, VGA, Side, AUDIO IN L/R** or **DIGITAL AUDIO IN**, a list appears which allows you to identify which type of peripheral equipment is attached to this input.
4. Press the cursor right again to enter the list of types of peripherals connected to the selected input.
5. Select the peripheral equipment with the cursor up/down.

Digital Audio In

If a peripheral equipment has a digital audio output, you can connect this with a single cable to the TV's **DIGITAL AUDIO IN** connector.

In the Connections menu, assign the **DIGITAL AUDIO IN** to the corresponding external input to which your peripheral equipment is connected.

In addition to accepting audio input via Digital Audio In, the TV can output encoded Dolby Digital audio via the **DIGITAL AUDIO OUT** connector to an external amplifier or receiver. If your amplifier or receiver has a matching connector for Digital Audio In, you can connect it with a single cable to the TV's **DIGITAL AUDIO OUT**. See To make video and audio connections, Connect a Home Cinema amplifier, p. 51.

Select a Decoder channel number

TV menu	
Installation	Decoder
.....	Channel
Time zone	Status
Channels	
Preferences	
Connections	
Decoder	
Factory settings	
Software upgrade	
Info	

This allows you to define one or more channel numbers as decoder channel numbers when a decoder or a descrambler is connected to **EXT1** or **EXT2**.

1. Select the channel number under which you have stored the programme that comes from your decoder or descrambler.
2. Select **Status**.
3. Select the input used to connect your decoder: **None, EXT1** or **EXT2**.
 - Select **None** if you do not want the selected channel number being activated as a decoder channel number.

Reset the Factory settings

EN

TV menu	
Installation	Factory settings
.....	
Time zone	Reset
Channels	
Preferences	
Connections	
Decoder	
Factory settings	
Software upgrade	
Info	

This allows you to reset most of the predefined factory states.

1. Select and press the cursor right.
2. Press the **OK** key to erase settings and reset them to their default values.

How to upgrade the TV software

TV menu	
Installation	Software upgrade
.....	Current softw. info
Time zone	Local upgrades
Channels	Announcement
Preferences	
Connections	
Decoder	
Factory settings	
Software upgrade	
Info	

This allows you to upgrade your TV software using a USB device.

USB device upgrade

It is possible to initiate an upgrade procedure from a USB device before you start up the TV. The memory device must be filled with the appropriate upgrade image (and structure) which can be found on the www.philips.com/support website. How to upload a new software version on your memory device, see Annex 1, Philips TV software upgrade with portable memory, p. 57.

Automatic software announcement (if present)

When you switch on your TV a message may appear that a new software upgrade is available.

- Press the red colour key on your remote control if you want to be reminded later on.
- Press the green colour key on your remote control to confirm you have read the message.
 - ▷ Once you have confirmed, the message will not pop up again.

If however, you want to see the last broadcasted announcement again, select **Announcement** in the Software upgrade menu.

Note: as long as the software upgrade has not been executed, the message will be available.

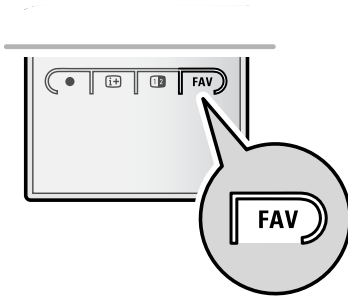

This allows you to select up to four favourite channels lists with your preferred TV channels and radio stations. For example, each member of your family can create his/her own favourite list. In addition to the favourite channel lists you may also select a list with only digital TV channels or a list with only the radio channels or a list with only the analogue channels.

Note: when this key is pressed the first time after you have finished the installation, it will bring up the full channel list. In other situations it will bring up the last selected channel list.

To select a channel from the displayed favourite list

1. Press the **FAV** key (or the **OK** key).
 - The last selected channel list appears.
2. Use the cursor up/down to select a channel.
3. Press the **OK** key to display the selected channel.

All channels	
EXT1	
EXT2	
HDMI	
1 Analogue channel 1	
2 Digital channel 1	
3 Digital channel 2	
4 Radio channel 1	
5 Data channel 1	
Change list	
Tune to a channel by pressing OK. Use -P+ for page up/down.	

To select another favourite channel list

1. Press the **FAV** key.
 - The last selected channel list appears.
2. Press the red colour key to bring up the list of possible favourite channel lists.
3. Use the cursor up/down to select a list.
4. Press the **OK** key.
5. Press the **FAV** key again to exit.

All channels	
All	
TV channels	
Radio channels	
Analogue	
Favourites 1	
Favourites 2	
Favourites 3	
Favourites 4	
Change list	
Use cursor up/down to select and OK to confirm.	

To create a favourite list or to modify the list

1. Press the **FAV** key.
 - The last selected channel list appears.
2. Press the red colour key.
 - A list with all possible favourite channel lists appears.
3. Use the cursor up/down to select a Favourites (1 to 4) channel list.
4. Press the **OK** key.
5. Press the green colour key to enter the Edit mode.
 - The selected Favourite list will bring up a full channel list.
6. Use the cursor up/down to select a channel.
7. Press the **OK** key to check or uncheck the highlighted channel and to add it to or remove it from your selected favourite list.
- 8a.
 - Press the green colour key again to leave the Edit mode.
 - The modified favourite channel list appears.
 - Press the **FAV** key again to exit.
 - With the **-P+** key you will be able to browse through the TV channels of the selected list.
- 8b. Press the red colour key to remove the channel list.

Note: with the digit keys you can still select channels which are not marked as favourite.

Favourites 1	
<input checked="" type="checkbox"/> EXT1	
<input checked="" type="checkbox"/> EXT2	
HDMI	
1 Analogue channel 1	
<input checked="" type="checkbox"/> 2 Digital channel 1	
<input checked="" type="checkbox"/> 3 Digital channel 2	
4 Radio channel 1	
5 Data channel 1	
Exit	Leave edit
Press the OK key to mark / unmark.	

To select only TV or only radio channels on the All channels list

When the All channels list is displayed or selected you may filter the list and select a list with only the TV channels or a list with only the radio channels.

1. Press the **FAV** key.
 - ▷ The last selected channel list appears.
2. Press the cursor left.
3. Select the All channels list and press the cursor right.
4. Press the red colour key to filter.
5. Select your desired channels list.
6. Press the **FAV** key again to exit.
 - ▷ With the **-P+** key you will be able to browse through the TV channels of the filtered list.

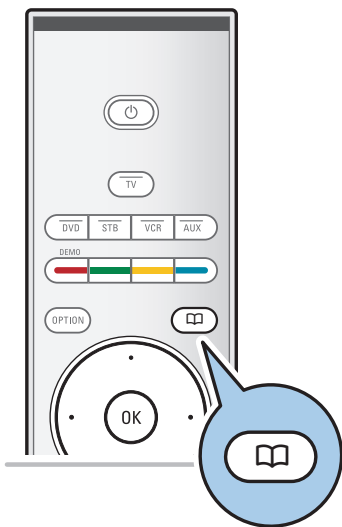

Note: the filtering will not be remembered after the TV is switched off or set to standby.

EPG (Electronic Programme Guide) (only with Digital TV channels)



The Electronic Programme Guide shows you detailed information about the current programme and also about the next programme (only for TV programmes that provide EPG information).

Note: these instructions may differ according to the type of Electronic Programme Guide.

1. Press the  key.
 - ▷ The EPG screen appears. Dependent on conditions it may take some time to acquire EPG data.
 - ▷ The EPG screen updates automatically if the EPG data is acquired successfully. If not, the EPG screen remains blank.
 - ▷ Information about the selected programme appears.
 - Use the coloured keys to activate the available EPG features displayed at the bottom of the screen.
2. To quit the Programme Guide page, press the  key again.

When the type of Electronic Programme Guide available, displays a list of TV programmes:

1. Use the cursor up/down to select a desired TV programme.
 - ▷ Information about the selected programme appears.

Tips:

- press the blue colour key on the remote control to view more information (not currently displayed) about the selected programme.
- to quit the display of detailed information, press the blue colour key again.

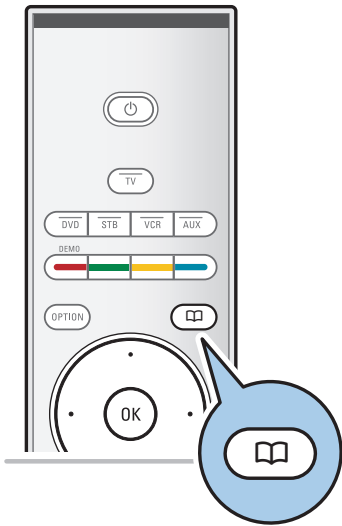

2. Press the green colour key on the remote control to watch/listen to the selected programme currently on air.
3. Press the red colour key to mark/unmark a reminder on the selected programme. You can set up to a maximum of 10 reminders.
 - ▷ The TV will wake up automatically or display a message when the programme is about to start. Follow the instructions on screen to watch the programme.
4. Press the yellow colour key to jump to the **Next** or the **Previous day** or back to **Today**.
5. Press the **MENU/BROWSE** key, while Programme Guide is active, to activate the Programme Guide main menu.
 - ° Use the cursor up/down to highlight and select a menu item.
 - **What's on** allows you to browse through the programme guide information of your preferred EPG channels.
 - **Search by genre** allows you to search for the programmes according to a selected genre.
 - **Scheduled reminders** allows you to view and change the reminders you have set.

Note: the reminder(s) will wake up your TV from standby only if you switched off your TV with the key on your remote control.

- **Preferred EPG channels** are the channels from which the EPG data is currently being acquired. This menu allows you to mark/unmark (up to 50) preferred EPG channels.

Note: after the installation of your channels, by default 40 channels with available EPG data will automatically be marked as preferred EPG channel.

- **Acquire EPG data** allows you to update the information for the preferred programme guide channels. Follow the instructions on screen.

Note: Acquisition of EPG data is done automatically while watching TV.

Programme Guide	What's on
What's on	12:00 South today
Search by genre	13:30 Working lunch
Scheduled reminders	12:30 Brainteaser
Preferred EPG chann..	12:00 This is BBC THREE
Acquire EPG data
Info	

6. To quit the Electronic Programme Guide, press the key again.

Tips:

- the EPG screen will not include TV channels which are not in the Preferred channel list or which are uninstalled (See Rearrange menu).
- new added channels (via reinstallation or installation) will have to be marked in the preferred EPG channel list before you can see EPG data.



The Multimedia browser lets you display pictures, movies or play audio files stored on a USB device. The Multimedia browser application is invoked from the main menu.

- Following file formats can be reproduced:
 - for pictures: JPEG
 - for audio: MP3, MP3 Pro, LPCM
 - for video: MPEG1, MPEG2
- Only FAT/DOS-formatted memory devices are supported.
- Philips can not be held responsible if your USB device is not supported.

To view content from a USB device

Tip: if your USB device does not fit into the USB connector at the side, use an USB extend cable to connect the USB device to the USB port. Ask your dealer for more information.

To insert a USB device

Note: USB devices are not supplied with this TV.

In case of a USB-memory stick or a digital camera, connect it to the USB connector at the side. See To make video and audio connections, Side panel overview, p. 44.

When a USB device is inserted, the Multimedia browser menu is displayed automatically. See further.

To remove the USB device

1. Press the **MENU/BROWSE** key on the remote control to switch off the main menu.
2. Remove the USB device.

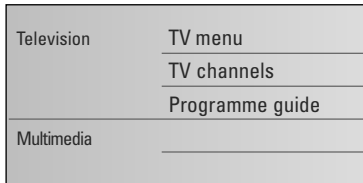

Multimedia Browser menu

1. Insert a USB device.
2. Select the USB device under Multimedia with the cursor up/down.
 - ▷ The Multimedia browser allows you to browse content stored on the inserted USB device.
 - ▷ The 2-panel browser will be shown with the left panel containing the content types (Music, Pictures, Movies).
 - ▷ The right panel will display the content that is available of the selected content type.
3. Press the cursor right to enter the content.
4. Press the cursor up/down to select a content.
5. Press the cursor right to enter the content.
6. Press the cursor up/down to select a file or a directory.

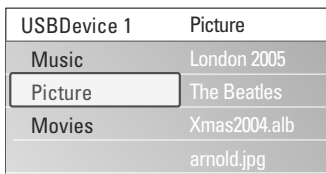

Note: press the green colour key to display all the image files in the current directory as thumbnails when browsing pictures. Press the green key again to display the image files in a list.

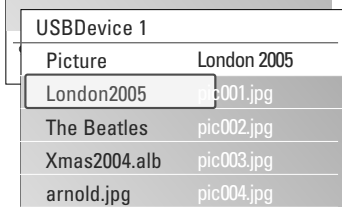

7. In case a **file** is selected, press the **OK** key to display a picture file or to play a video or an audio file. In case a **directory, album or playlist** is selected, press the cursor right to enter the content or press the **OK** key to start a slide show or a loop playback of the files present.
8. Press the cursor left to keep music playing and switch back to the Multimedia menu.
9. Press one of the colour keys on the remote control to perform the corresponding function mentioned at the bottom of the screen.

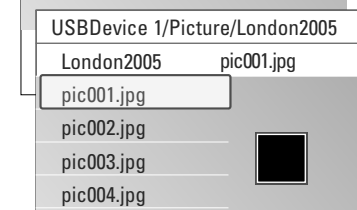

Tip: the blue colour key can, if necessary, be used to let the colour keys reappear.

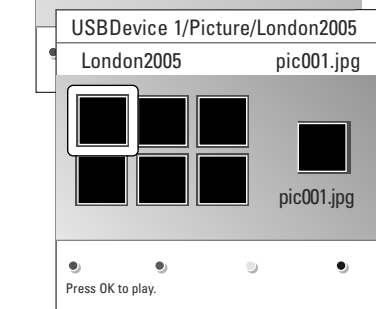





10. To stop playing content, press the  key on the remote control.

Notes:

- your TV supports slide shows with background music. See Annex 2, Philips TV-slideshow format with background music, p. 59;
- the playback will continue to play even if temporarily switched to browser screens. The audio will be stopped when another song starts playing, or when the end has been reached;
- more technical remarks can be found in Annex 3, Philips TV-Digital camera and USB issues, p. 61.

Following icons may appear:

- | | |
|----------------------------------------------------------------------------------------------|---------------------------------------------------------------------------------------------------------------|
|  folder |  self made playlist/album |
|  pictures |  video |
|  music | |

Function keys at the bottom of the screen

Details	to display a description of the selected file or directory
Transitions	to select if you like to apply a transition during a slide show
Slide time	to select the duration a picture will be displayed in a slide show
Rotate	to rotate a picture
Repeat one/all	to repeat the playback of a music file
Shuffle	to shuffle music collections in a random way
Zoom	to select one of the zoom magnifications (x1, x2, x4) with the cursor up/down. Additionally you can shift the selected zoom window over the screen with the cursor keys.
Full/small screen	to toggle between a full or a small screen

Note: to rotate a picture or to select one of the zoom magnifications, first stop the slide show with the **OK** key or the blue colour key.

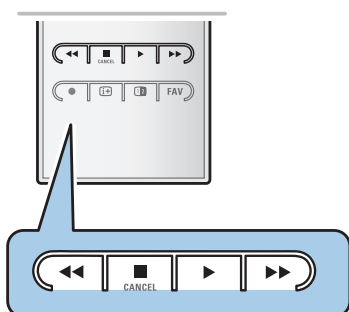

Multimedia function keys on the remote control

- ◀◀ to fast rewind displaying content
- to stop playing content
- ▶ - to play a single file, start a slide show, playback of a folder or other collection
- to pause playing content
- ▶▶ to fast forward displaying content



Note: Teletext is not available via equipment connected to the **HDMI** connector.

Most TV channels broadcast information via teletext. This TV has a 1200 pages memory that will store most broadcasted pages and subpages to reduce waiting time. After each programme change, the memory is refreshed.

- Press  to switch the teletext on.
 - ▷ The main index page appears on the screen.

Select a Teletext page

- Enter the desired page number with the digit keys or with the **-P+** key.
- Select the options at the bottom of the screen with the colour keys.

Previous selected teletext page

- Press the **P+P** key.

Select T.O.P. teletext broadcasts





- Press .
 - ▷ A T.O.P. overview of the teletext subjects available is displayed.
- Select with the cursor up/down, left/right the desired subject and press the **OK** key.

Note: not all TV channels broadcast T.O.P. teletext.

Select subpages

When a selected teletext page consists of different subpages, a list of available subpages appears on the screen. Press the cursor left or right to select the next or previous subpage.

Picture/Teletext

1. Press the  key.
2. Press the  key to show Teletext on the right of the screen.
3. Press the  key to return to a full teletext picture.
4. Press the  key to return to a full screen picture.



Menu	
Reveal	Off
Cycle subpages	Off
Language	Gr. II

Hypertext

With hypertext you can quickly jump to a pagenumber or search for a specific word shown on the current teletext page.

1. Press the **OK** key to highlight the first word or a number on the page.
2. Use the cursor up/down, left/right to select any other word or number you want to search for.
3. Press the **OK** key to confirm. The search starts.
 - A message appears at the bottom of the screen to indicate the searching, or that the word or page is not found.
4. Use the cursor up until the top of the page to exit hypertext.

Enlarge a Teletext page

- Press the **OPTION** key on the remote control repeatedly to display the upper teletext part, the lower teletext part and then to return to the normal teletext page size.

Teletext menu

The Teletext menu offers various functions to control teletext.

1. Switch teletext on and press the **MENU/BROWSE** key to activate the menu.
2. Press the cursor up/down to select the menu items.
3. Press the **OK** key to activate.
4. Press the **MENU/BROWSE** key to leave the teletext menu.

Reveal

Reveals/conceals hidden information on a page, such as solutions to riddles and puzzles.

Cycle subpages (if subpages are available)

Makes the subpages cycle automatically.

- Press the **OK** key to activate and to deactivate again.

Language

If the displayed characters on screen do not correspond with the characters used by the teletext broadcaster, you can change the language group here.

- Select **Group I** or **Group II** with the **OK** key.

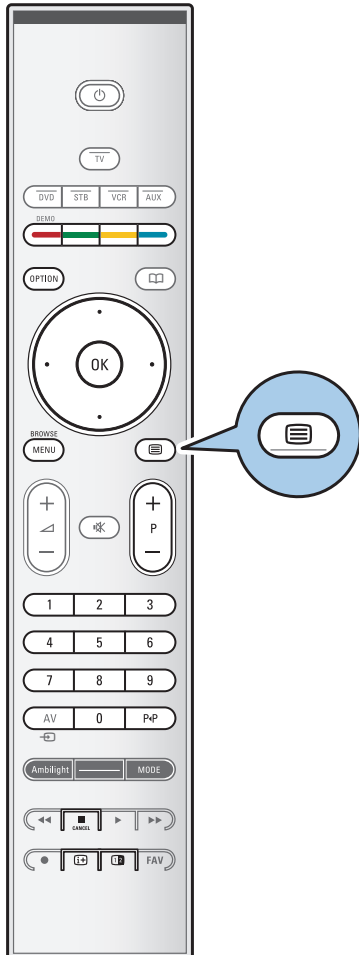

Digital text (only for UK)

Some digital channels offer dedicated digital text services (for example BBCi).

1. Press  to switch Digital text on.

Note: UK only: Digital text is displayed when programmes are carrying digital text or interactive services.

2. To use the digital text, follow the instructions on screen.
3. Depending on the service, you may be asked to use the cursor keys, the **OK** key, the coloured keys, the teletext key and sometimes the digit keys.
4. When you have finished watching teletext, select a different channel with the **-P+** keys or follow the instructions on screen to return to picture.
5. Press  **CANCEL** to cancel digital text or interactive services.

Text info

Some digital channels also offer information on the programme being broadcast. In that case a message may appear at the bottom of the screen for a few seconds. Follow the instructions on screen and use the cursor keys to scroll through the next pages.

Note: digital text will not be available when Subtitles are set to On in the Features menu.

To make video and audio connections

EN













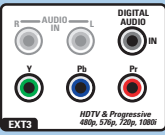

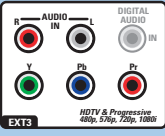

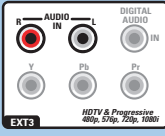
Tip: use the inputs that are available on your equipment that provide the best video or audio performance, as below.

Note: your TV comes with all types of connectors with the exception of the DVI connector but some of your equipment may be equipped with this type. In this case you'll need a DVI to HDMI adapter or a HDMI to DVI cable and separate audio cables, all available at your local dealer.

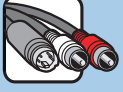
Warning: be sure to connect the DVI output connector first, then connect to the HDMI input on your TV.

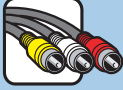
Best video performance



	Connector table	Audio connection required
 HDMI	HDMI (High-Definition Multimedia Interface) 	No
	Component video (480p/576p/720p/ 480i/576i/1080i)  Digital audio	Yes 
	Component video (480p/576p/720p/ 480i/576i/1080i)  Analog audio	Yes 
 EUROCONNECTOR	Scart 	No
 S-VIDEO	S-Video 	Yes 
 VIDEO	Video 	Yes 
 75 Ω	RF/Coaxial 	No

Notes:

- cables are often colour-coded to connectors. Connect red to red, white to white....
- component video (YPbPr) connection is necessary to view video sources, for example digital broadcastings coming from a HD receiver; in 1080i, 720p, 576i, 576p, 480i or 480p,
- PC equipped with a VGA connector, see p. 50.

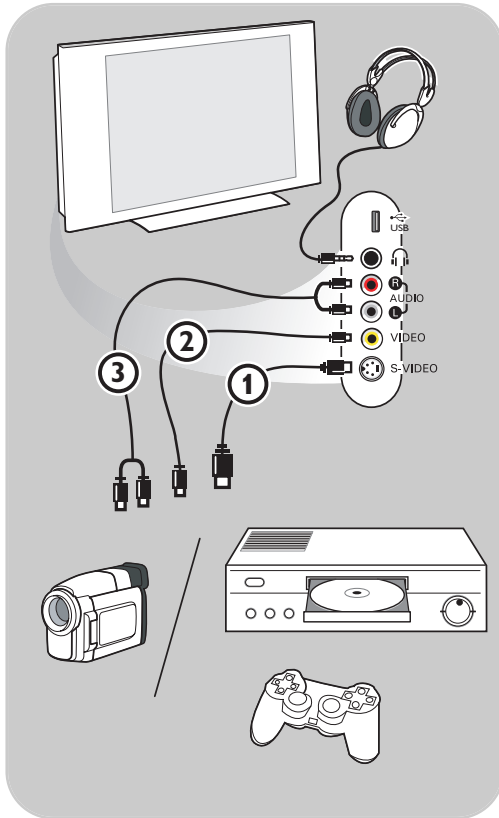

Camera, Camcorder, Game

1. Connect your camera, camcorder or game as shown.
2. Connect to **VIDEO** (2) and **AUDIO L** (3) for mono equipment. For stereo equipment also connect **AUDIO R** (3).
S-VHS quality with an S-VHS camcorder is obtained by connecting the S-VHS cables with the **S-VIDEO** input (1) and **AUDIO** inputs (3).

Warning: do not connect cable (1) and (2) at the same time. This may cause picture distortion !

Headphone

1. Insert the plug into the headphone socket as shown.
2. The headphone impedance must be between 8 and 4000 Ohm. The headphone socket has a 3.5 mm jack.
In the Sound menu select **Headphone volume** to adjust the headphone volume.

Tip: Press  on the remote control to switch off the internal loudspeakers of the TV.

USB

See Multimedia browser, p. 37.

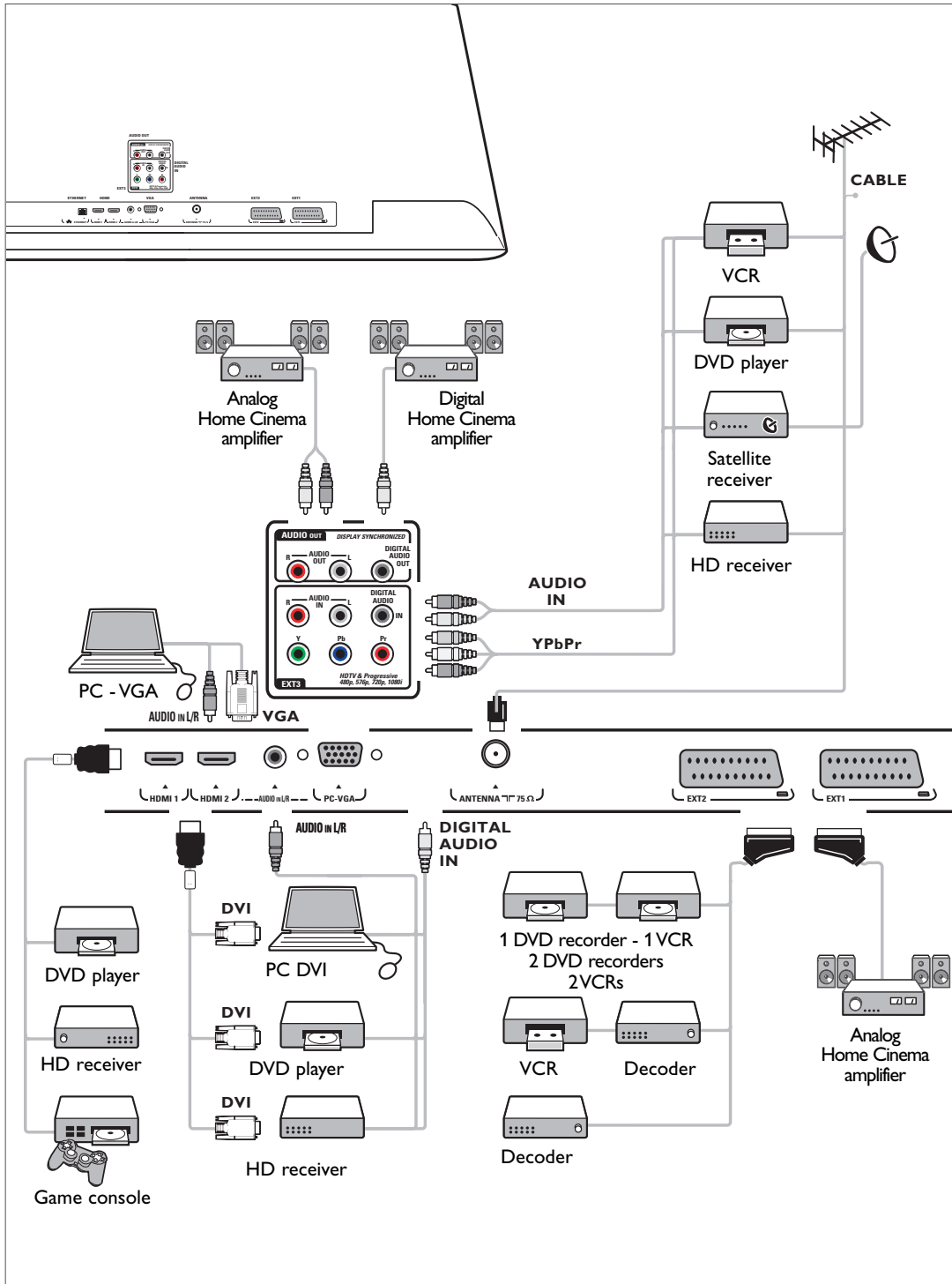

Warning: do not place your recorder too close to the screen as some recorders may be susceptible for signals from the display. Keep a minimum distance of 0,5 m from the screen.

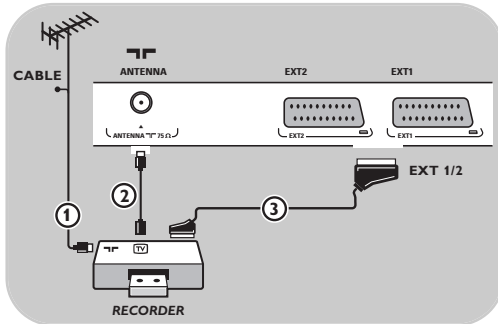

With a eurocable

1. Connect the aerial cables ① and ② as shown.
2. Connect the eurocable ③ as shown.
3. Make your selection of the source to which the VCR has been connected in the Installation menu, Select your connections, p. 32.

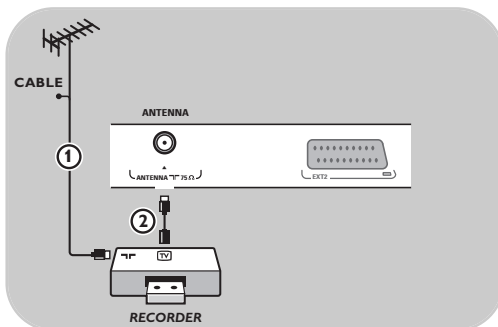

With the aerial cable only

1. Connect the aerial cables ① and ② as shown.
2. Tune in your recorder's testsignal and store the testsignal under programme number 0. See Analogue: manual installation, p. 29. See also the handbook of your recorder.

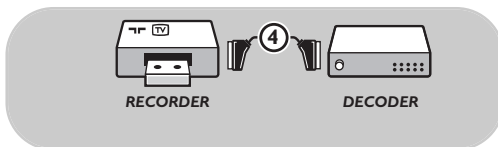

Connect a decoder and a VCR

Connect a eurocable ④ to your decoder and to the special euroconnector of your recorder. See also the handbook of your recorder.

Tip: you can also connect your decoder directly to **EXT1** or **EXT2** with a eurocable.

Connect two VCRs or VCR and DVD recorder

EN

Note: you can not record signals from equipment connected to the **YPbPr** input.

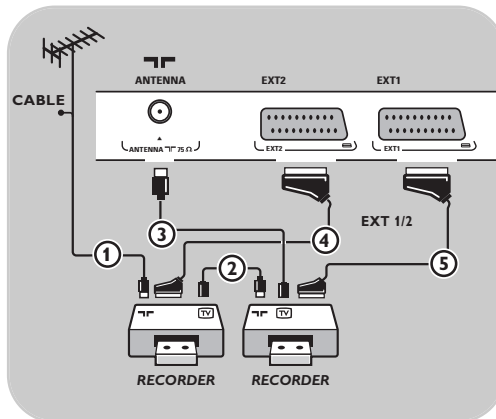

With eurocables

1. Connect the aerial cables ① and ② as shown.
2. Connect your VCRs or DVD-recorder to **EXT1** and **2** with the eurocables ④ and ⑤.
3. Select the equipment you have connected in the Installation menu, Select your connections, p. 32, and link it to **EXT1** or **2**.

With aerial cables only

1. Connect the aerial cables ①, ② and ③ as shown.
2. Tune in your recorder's testsignal and store the testsignal under programme number 0. See Analogue: manual installation, p. 29. See also the handbook of your recorder.

Connect a satellite receiver

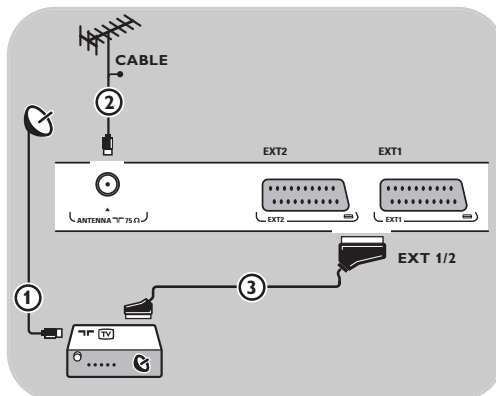

With a eurocable

1. Connect the aerial cables ① and ② as shown.
2. Connect your satellite receiver to **EXT1** or **2** with a eurocable ③.
3. Select the equipment you have connected in the Installation menu, Select your connections, p. 32, and link it to **EXT1** or **2**.

With Component Video connectors

See Connect a DVD player, a satellite receiver or a HD receiver, p. 49.

Connect a DVD player, HD receiver or game console

Tip: if necessary, you can adjust the picture position to the centre of the screen with the cursor keys.

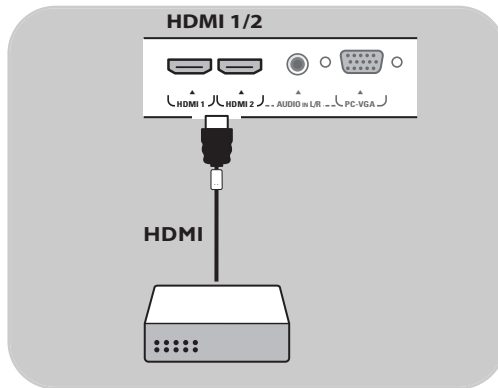

With a HDMI connector

HDMI is the leading new standard for Digital video and audio interconnection.

1. Connect your equipment with the **HDMI** connector.
2. Select the equipment you have connected in the Installation menu, Select your connections, p. 32, and link it to **HDMI 1** or **2**.

Note: in case of any problems, see Annex 4: Issues referring to connected peripherals with a HDMI connector; p. 62.

Connect a DVD player or HD receiver

Tip: if necessary, you can adjust the picture position to the centre of the screen with the cursor keys.

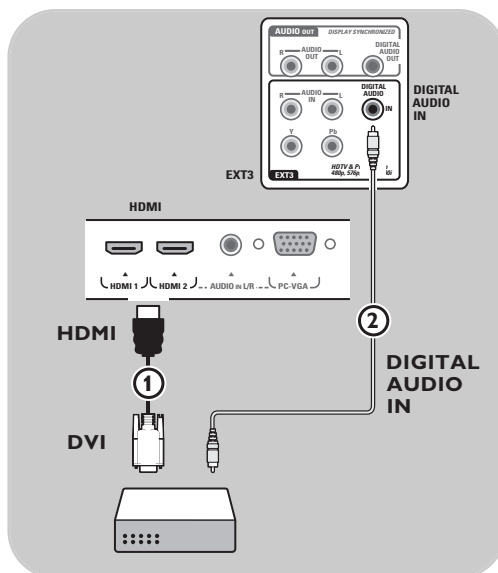

With a DVI connector

Note: only a DVD player with DVI with digital sound can be connected to the **HDMI** connector.

1. Connect the DVI to HDMI cable to one of the HDMI connectors of your TV ①.
2. Connect the audio cable ② to the **DIGITAL AUDIO IN** connector of the TV.
3. Select the equipment you have connected in the Installation menu, Select your connections, p. 32 and link it **HDMI 1** or **2**.
4. Also select **DIGITAL AUDIO IN** in the same Connections menu.

Tip: if necessary, you can adjust the picture position to the centre of the screen with the cursor keys.

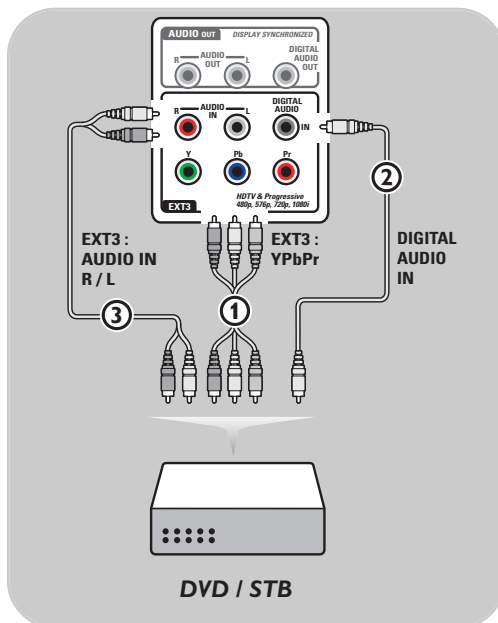

With Component Video Connectors

1. Connect the three separate component video cables ① to the YPbPr jacks on the DVD player and to the **Y, Pb** and **Pr** jacks of **EXT3** on the TV.
2. Connect the audio cable ② to the digital out of the equipment and to the **DIGITAL AUDIO IN** connector of the TV.
3. Select the equipment you have connected in the Installation menu, Select your connections, p. 32 and link it to **EXT3**. Also select **DIGITAL AUDIO IN** in the same Connections menu.
4. In case of a DVD player with analogue audio, connect the audio cable to the DVD's audio **L** and **R** jacks and to the **AUDIO IN L/R** jack of **EXT3** ③.
5. In case of a HD receiver and/or a satellite receiver also connect the cable TV cable and/or the satellite antenna cable ④ and the aerial cable ⑤.

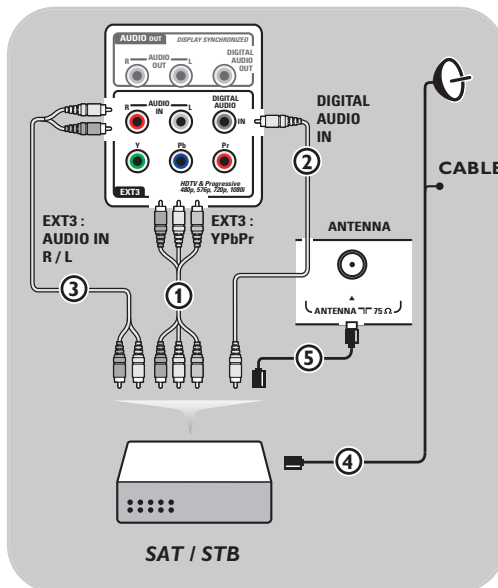

Notes:

- cables are often colour coded. Connect red to red, white to white, etc.;
- the labels for the component video sockets may differ depending on the DVD player connected. Although the abbreviations may vary, the letters **B** and **R** stand for the blue and red component signals, respectively, and **Y** indicates the luminance signal. Refer to the DVD player's instructions for use for definitions and connection details;
- to get an optimal viewing, it is advised to switch your equipment to the highest possible supported display modes.

Warning: in case you notice scrolling images, wrong colours or no colour, no picture, or even combinations of these on your screen, verify if the connections are done in the correct way and if the resolution and the signal standard of the connected equipment are set in the right way. See the handbook for your equipment.

Notes:

- only a PC with digital sound can be connected to the **HDMI** connection;
- if your PC does not have digital sound output, connect your PC via a **VGA** connector;
- before connecting your PC to the TV, select your PC monitor settings to a refresh frequency of 60 Hz;
- supported PC monitor modes:
 - VGA 640 x 480
 - SVGA 800 x 600
 - XGA 1024 x 768

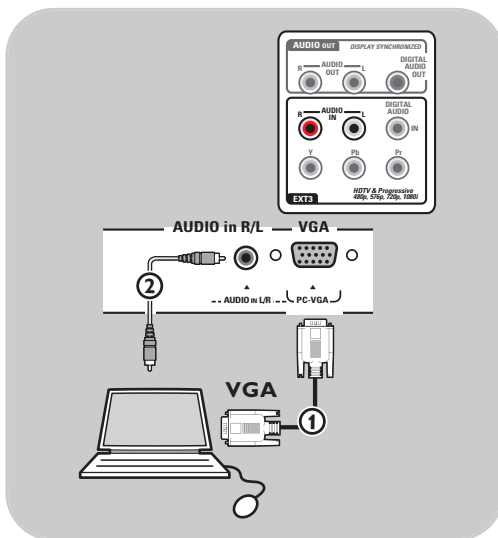
**PC equipped with a VGA connector:**

1. Connect one end of a **VGA** cable ① to the video card of the computer and the other end to the **VGA** connector at the bottom of the TV. Fix the connector firmly with the screws on the plug.
2. In case of a Multimedia computer, connect the audio cable ② to the **AUDIO** outputs of your computer and to the **AUDIO IN L/R** input of the TV.
3. Select **VGA** in the Installation menu, Select your connections, p. 32 and link it to **VGA**.
4. Also select **AUDIO IN L/R** in the same Connections menu.

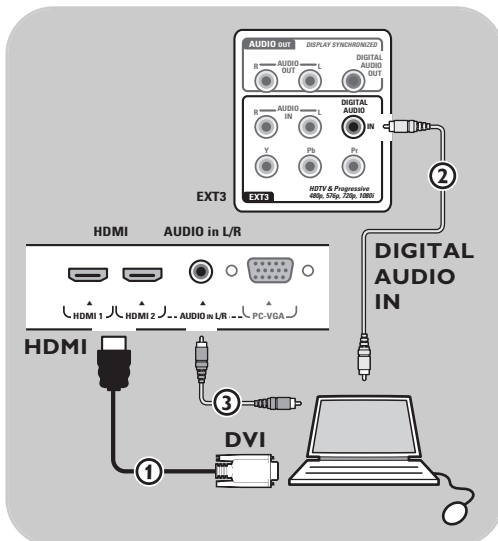
**PC equipped with a DVI connector:****With Digital audio**

1. Use a **DVI to HDMI** cable to connect to one of the **HDMI** connector of your TV ①.
2. Connect the audio cable ② to the **DIGITAL AUDIO IN** connector of the TV.
3. Select the computer you have connected in the Installation menu, Select your connections, p. 32 and link it to **HDMI 1** or **2**.
4. Also select **DIGITAL AUDIO IN** in the same Connections menu.

With Analogue audio

1. Use a **DVI to HDMI** cable to connect to the **HDMI 2** connector of your TV ①.
2. Connect the audio cable ③ to the **AUDIO IN L/R** input of the TV.
3. Select the computer you have connected in the Installation menu, Select your connections, p. 32 and link it to **HDMI 2**.
4. Also select **AUDIO IN L/R** in the same Connections menu.

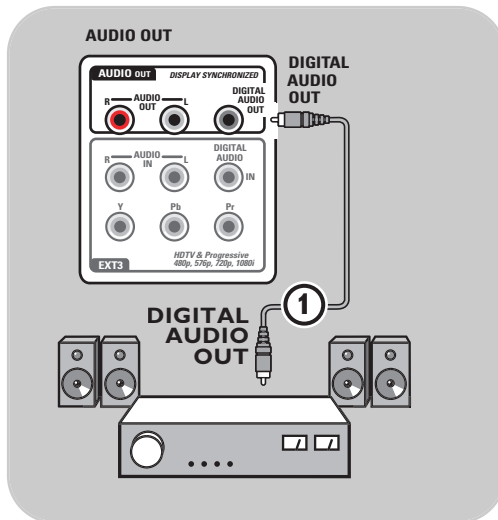

Digital Home Cinema amplifier

- Connect a digital Home Cinema amplifier to the **DIGITAL AUDIO OUT** connector ① at the bottom of the TV.

Tip: to avoid visible delay between picture and sound, use this **DIGITAL AUDIO OUT** connector to connect your Home Cinema amplifier.

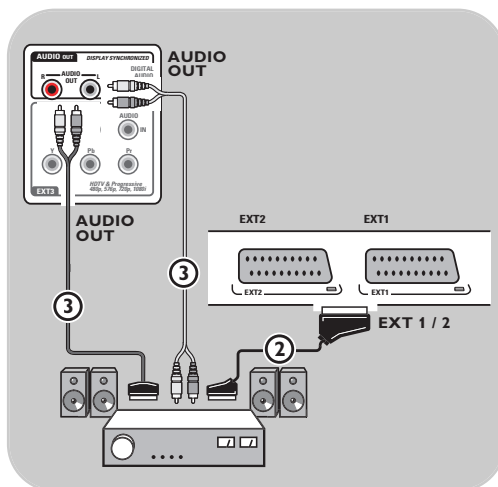

Analogue Home Cinema amplifier

- According to the type of connector cables and the connector input available on your Home Cinema amplifier, connect your receiver to the **AUDIO OUT L and R** connectors ③ or to **EXT1** or 2 ② at the bottom or the rear of the TV.

Warning: switch off your TV before any module is inserted in the Common Interface slot.

Note: this functionality is only available in certain countries.

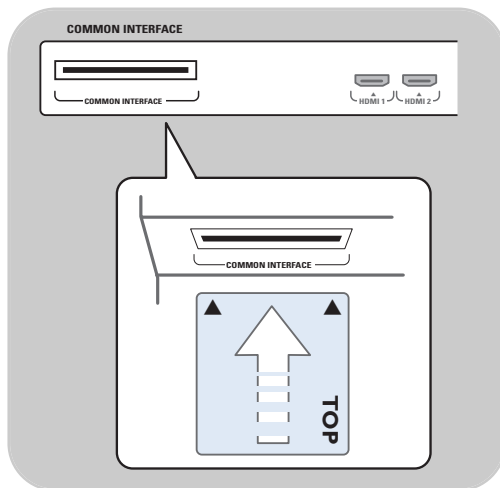

To receive scrambled DTV signals you will need a CA (Conditional Access) module and a Smart card provided by the service provider.

A CA module can enable additional services, for example Pay TV.

Contact your Common Interface service provider to get more information about these modules.

Although CA module types may vary dependent on the manufacturer, each one of the CA modules supports a certain kind of encryption system. Your TV supports CA modules to work with the DVB-T standard.

Note that a smart card may only be valid for a single broadcast channel.

CA modules and smart cards are neither supplied nor optional accessories from Philips.

The CA module is responsible for the messages and texts on screen. In case of failure or strange behaviour, you must call your CI service broadcaster.

Insert a CA module

- Insert the specified Conditional Access module into the Common Interface slot as far as it will go. It may take a few minutes before the CA module is activated and service information is downloaded.

Warning: when you connect the CA module incorrectly, it may damage the card and the TV. After inserting a card, leave it in the slot permanently. Do not remove it from the slot unless asked to do so. For example, your card has to be in the slot when your CI service broadcaster wants to download new information to the smart card. Once the CA module is removed, your TV will no longer decrypt scrambled digital DVB-T channels.

To access common interface applications, see TV menu, Adjust feature menu settings, Common Interface, p. 26.

Select connected equipment

EN



Before operating your connected equipment you have to make a selection in the Installation, Select your connections menu, p. 32.

1. Press the **MENU/BROWSE** key.
2. Select **TV menu** and press the cursor right.
3. Select **Installation**.
4. Press the cursor right.
5. Select **Connections**.
6. Press the cursor right.
7. Select the input to which the peripheral equipment is connected.
8. Press the cursor right again to enter the list of types of peripherals connected to the selected input
9. Select the peripheral equipment with the cursor up/down.

Record with your recorder

Note: to record digital programmes to an analogue recorder, the TV needs to be switched on and tuned to that digital programmes.

Record a TV programme

You can record a TV programme using your recorders tuner without affecting your TV.

1. Select the channel number on your recorder.
2. Set your recorder to record.
See the handbook for your recorder.

Note: when recording analogue programmes, switching channel numbers on your TV does not disturb recording !



Most of the audio and video equipment from our range of products can be operated with the remote control of your TV. Press one of the keys after you pressed one of the mode keys (**DVD, STB, VCR, AUX**) according to the equipment you want to operate with this remote control.

See Use of the Remote control, p. 5-6.

	to switch to standby
	for record,
	for rewind (VCR, CD);
	search down (DVD)
	for stop,
	for play, for pause
	for fast forward (VCR, CD);
	search up (DVD)
	to display information
MENU/BROWSE	to switch the menu on or off
- P +	for chapter; channel, track selection
0 to 9	digit entry,
cursor up/down	to select the next or the previous disc (CD)
cursor left/right	to select the previous or following track (CD)
P+P	to select a DVD title/chapter; index (AUX)
	to select your choice of subtitle language (DVD)

Normal mode: if no action is being undertaken within 30 seconds, the remote control returns to TV mode.

Expert mode: in Expert mode the remote will stay in the selected mode even when the 30 seconds time-out is elapsed.

To select between Normal and Expert mode

1. Select TV mode with the **TV** key.
2. Press the **OK** key simultaneously with the key for four seconds.
 - When the key is On for one second, the Expert mode is selected and the remote control will remain in the mode selected.
3. Select the desired mode (**DVD, STB, VCR, AUX**)
4. To go back to the TV mode, select **TV** and repeat steps 1 to 3.

Symptom	Possible cause/Remedy
No picture	<ul style="list-style-type: none"> ◦ Verify if the supplied cables are connected properly. (The aerial cable to the TV, the other aerial to your recorder, the power cables, ..) ◦ Verify if you selected the correct source. ◦ Verify if the child lock has been switched off.
Poor picture	<ul style="list-style-type: none"> ◦ Verify in the Manual installation menu if you have selected the correct TV system. ◦ Verify if your TV or house aerial isn't located too close to loudspeakers, non-earthed audio equipment or neon lights, etc. ◦ Mountains or high buildings can cause double pictures or ghost images. Sometimes you can improve the picture quality by changing the direction of the aerial. ◦ Is the picture or teletext unrecognisable or do you experience bad teletext reception ? Verify if you have entered the correct frequency, or fine tune the frequency for that specific channel or adjust the antenna direction if the problem isn't solved by finetuning. See Installation, Analogue: manual installation, p. 29.
Poor colour	<ul style="list-style-type: none"> ◦ Select Factory settings in the Installation menu. ◦ Verify the connections between the optional equipment and the TV.
No sound	<ul style="list-style-type: none"> ◦ Verify if the volume isn't at minimum. ◦ Verify if the sound hasn't been muted with the  key. ◦ Verify the connections between the optional equipment and the TV.
Sound and picture interruptions using HDMI to HDMI connection	<ul style="list-style-type: none"> ◦ If it occurs occasionally, perhaps there is something wrong with the broadcasted programme. ◦ If it occurs persistently, see the manual of your connected equipment to verify the necessary adjustments. ◦ Alternatively, connect an extra audio cable (either an analogue or a digital audio cable) from your connected peripheral to your TV. Verify whether you selected the connected equipment in the Installation menu, Select your connections and also select the respective audio input in the same Connections menu. Note: An analogue audio cable must be linked to HDMI 2. ◦ Limit the HDMI cable length to max 5 m. ◦ Verify if the connected equipment is properly selected in the Installation menu, Connections, according to the connection you have made HDMI 1 or 2.
No sound when using DVI to HDMI connection	<ul style="list-style-type: none"> ◦ Verify whether you properly connected the audio cable to the DIGITAL AUDIO IN connector of the TV. ◦ Verify whether you selected the connected equipment in the Installation menu, Select your connections and if you linked it to HDMI 1 or 2 according to where you made the connection. ◦ Also verify if you selected digital audio in in the same Connections menu.
No digital channels	<ul style="list-style-type: none"> ◦ Contact your dealer about Digital Video Broadcasting Terrestrial signal availability in your country.
No subtitles (UK ONLY)	<ul style="list-style-type: none"> ◦ Under certain circumstances Digital text or interactive services may have priority over subtitles. This can result in the subtitles not automatically reappearing when leaving Digital text or interactive services on a channel which is broadcasting subtitles. In these cases subtitles can be initialised, either by toggling the OPTION or the MENU key on the remote control or by changing channel.

Symptom	Possible cause/Remedy
The remote does not function	<ul style="list-style-type: none"> ◦ Verify if the remote is set correctly for the equipment your are using. ◦ Verify if the batteries are not dead. Replace the batteries. You can still use the keys at the right side of the TV. ◦ Select TV mode on your remote control. ◦ When pressing a key and some key leds are blinking with a higher speed and lower intensity than in a normal working condition, and your TV does not react on the key press, remove the batteries out of the remote control and put them back again.
The remote of connected equipment does not function well	<ul style="list-style-type: none"> ◦ The infrared signals of the screen may influence the reception sensibility of other peripherals. Solution: replace the batteries of the remote of other peripheral equipment.
No photo or music play or in poor quality	<ul style="list-style-type: none"> ◦ Verify if the source complies with a supported code.
No stable or not synchronised VGA picture	<ul style="list-style-type: none"> ◦ Verify if you have selected the correct VGA mode in your PC. See Connect a PC, p. 50. ◦ Verify the connections between the TV and the PC.
No solution found for your picture or sound problem	<ul style="list-style-type: none"> ◦ Switch off your TV off and then on again once. Never attempt to repair a defective TV yourself. Verify with your dealer or call a TV technician.
Red blinking led	<ul style="list-style-type: none"> ◦ Unplug the mains cord for 10 seconds and insert it in again.
Black bars with HD channels	<ul style="list-style-type: none"> ◦ Select another picture format.
No EPG data available	<ul style="list-style-type: none"> ◦ The Electronic Programme Guide function and background programme information are only made available by TV channels that provide EPG information and in countries which support EPG. See www.philips.com/support.

Introduction

Philips continuously tries to improve its products and it wants you to profit of that even after your purchase. Therefore it allows you to upgrade your TV software using a USB memory device (not supplied). You can execute the software upgrade procedure yourself.

TV menu	
Installation	Software upgrade
.....	Current softw. info
Time zone	Local upgrades
Channels	Announcement
Preferences	
Connections	
Decoder	
Factory settings	
Software upgrade	
Info	

Verifying the version of the TV software

Before starting the software upgrade procedure, it is advised to check what your current TV software is.

1. Select **Software upgrade** in the Installation menu.
2. Press the cursor right.
The Software upgrade menu moves to the left panel.
3. Select **Current software info** to observe the version and the description of the current software.

Preparing a USB portable memory for software upgrade

What do you need ?

- A personal computer with web browsing capability.
- An archive utility that supports the ZIP-format (e.g. WinZip for Windows).
- A preferably empty USB portable memory.

Note: Only FAT/DOS-formatted portable memory is supported.

New software can be downloaded from the www.philips.com/support website.

1. Insert a USB portable memory device into a PC linked to the internet.
2. Go to www.philips.com/support.
3. Choose your country or area/language.
4. Enter your model number.
5. In the **Search results**, click on the model number.
6. Under **Product support**, click on **Software and drivers**.
7. Click on the **Firmware Upgrade zip file**.
8. Click on the **Download** arrow in the upper left corner of your screen.
9. Save the latest software upgrade file to your computer.
10. Double click on the zip-file and copy the file "autorun.upg" to the root directory on the USB portable memory.

Note: Only use software upgrades that can be found on the www.philips.com/support website.

Upgrade the TV software

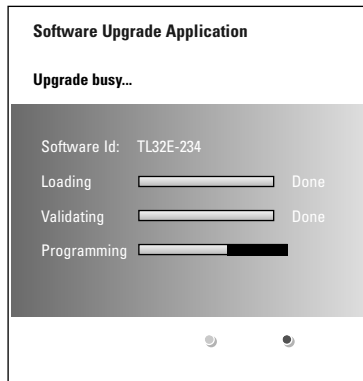

1. Switch off your TV and remove all memory devices.
2. Insert the USB portable memory that contains the downloaded software upgrade.
3. Switch on your TV with the power key  at the side of the TV.
4. The upgrade process starts automatically. After a few seconds the status of the upgrade procedure is displayed.

Warning:

- You are not allowed to remove the USB portable memory during the software upgrade procedure;
- In case of a power drop during the upgrade procedure, don't remove the USB portable memory from the TV. The TV will continue the upgrade as soon as the power comes back;
- If an error occurs during the upgrade you should retry the procedure or contact your Local Customer Service Centre.

5. When the message **Operation successful** appears, remove the USB portable memory and restart your TV with the power switch  at the side of the TV. Your TV will start up with the new software.

Note: once the upgrade is finished use your PC to remove the TV software from your USB portable memory.

If you need further assistance or in case of problems, please call your local Philips Customer Centre. See Philips Consumer Care on the www.philips.com/support website.

TV menu	
Installation	Software upgrade
.....	Current softw. info
Time zone	Local upgrades
Channels	Announcement
Preferences	
Connections	
Decoder	
Factory settings	
Software upgrade	
Info	

Local software upgrade procedure

New software, or the currently installed software version, can also be obtained from the www.philips.com/support website.

1. Go to **www.philips.com/support** using the web browser of your PC.
2. Follow the procedure to find the information and the software related to your TV.
3. Select the latest software upgrade file and download it to you PC.
4. Decompress the ZIP-file.
Rename the resulting file "autorun.upg" to for ex. "upgrade.upg".
Move the renamed file to the subdirectory "Upgrades".

Remark: if there is no subdirectory "Upgrades" present, please create one.

5. Insert the portable memory that contains the downloaded software upgrade.
6. Select **Software Upgrade** in the Installation menu. Go to **Local upgrades**.
The TV will list all compatible software available on the USB portable memory and display the data for each selected upgrade version.
7. Select the correct upgrade version and press the red colour key to start the upgrade.
Your TV will restart and will automatically go to the upgrade mode. After a few seconds it will display the status of the upgrade procedure.

Warning: if you try to upgrade to a software version equal or lower than the current version, a confirmation will be asked. Downgrading to older software should only be done in case of real necessity.

8. When the software upgrade was successful, remove the USB portable memory and restart your TV with the power switch (⏻) at the side of the TV. Your TV will start up with the new software.

Note: Only use software upgrades that can be found on the www.philips.com/support website.

Notes:

- the latest version of this document can be found on the Philips support website (www.philips.com/support).
- Use the type number of your TV to find this documentation and other related files.
- Philips can't be held responsible for any problems that may occur as a result of the content in this document. Errors reported to Philips will be adapted and published on the Philips support website as soon as possible.

Introduction

This document explains how to make a Philips slideshow file with background audio. Be aware that the content of this document is addressing technical or software skilled users. To start the slideshow open the slideshow file in the Multimedia browser of your TV.

1. Press the **MENU/BROWSE** key on the remote control after having inserted a USB device and switched on the TV.
2. Go to where you stored the slideshow file (.alb) on your portable memory.
3. Select the slideshow file and press the **OK** key to start the slide show.
4. To stop a slide show, press the **■** key.

General Rules

- The slideshow will use plain ASCII XML syntax to allow the creation and editing of the slideshow files using simple tools.
- All references to network content must be based on the global address of the content.
- Content on a Portable Memory (PM) doesn't have a global address; as a result content from a PM can never be referenced from a slideshow not stored on the PM itself.
- To maintain portability, a slideshow stored on a PM should **ONLY** reference content on the same PM. Referencing global addresses can result in inconsistencies if the PM is used on a non-networked CE device. The latter is however not forbidden, it is only a recommendation.
- It is preferable that URL's referencing PM content are based on a relative path starting from the directory where the slideshow is stored. This path includes the device or drive name of the PM. An absolute path to content will also be supported.
 - relative path: pictures\test1.jpg, tamper.jpg, ..\new\bird.jpg, ...
 - absolute path: USB1:\pictures1\foo_bar.jpg, C:\f1.jpg, \organization.jpg, ...

General Format

The format and syntax below will be used to create the slideshow file (simple ascii text) with the extension .alb (.ALB). Examples: slshow1.alb, summer_holiday_2004.ALB, test.alb, ...

The following syntax should be used to create the text file:

```
<?xml version="1.0" encoding="ISO-885h9-1" ?>
<philips-slideshow version="1.0" >
  <title>Title of the slideshow</title>
  <audio>audio_url</audio>
  <slide-duration>30</slide-duration>
  <slides>
    <slide>slide_1_url</slide>
    <slide>slide_2_url</slide>
    <slide>slide_3_url</slide>
    <slide>slide_4_url</slide>
    <slide>slide_5_url</slide>
    <slide>slide_6_url</slide>
    ...
    <slide>slide_N-1_url</slide>
    <slide>slide_N_url</slide>
  </slides>
</philips-slideshow>
```

Supported XML-tags

The following table gives a description of the XML syntax.

Tag Name	Use	Description
philips-slideshow	mandatory	Philips slideshow signature including the version.
title	optional	The title of the playlist.
audio	optional	The audio-URL following this tag will define the music playing in the background during the slideshow. A single song or playlist (.m3u & .pls) are the only valid audio references. Other reference will not result in any audio playback. If a single song is referenced the song will be repeated forever. If a playlist is referenced the playlist will be played in sequence with a repeat at the end of the playlist.
slide-duration	optional	The default display time (in 0,1 second) of a slide. The TV application isn't obliged to support this tag. The TV application can force the use of one or multiple predefined display times.
slides	mandatory	Identifies the slides to show.
slide	optional	Identifies the URL of the individual slide.

Notes:

- the latest version of this document can be found on the Philips support website (www.philips.com/support);
- the software of your TV is upgradeable. If you have problems first check if you have the latest software installed on your TV. The latest software, together with instructions, can be found on the Philips support website. Use the type number of your TV to find this documentation and other related files.
- Philips can't be held responsible neither for any errors in the content of this document nor for any problems as a result of the content in this document. Errors reported to Philips will be adapted and published on the Philips support website as soon as possible.

Digital Camera Issues

If a USB connection between your digital camera and the TV isn't working, you can try the solutions below to resolve your problem.

- Make sure your digital camera is switched on and verify if the configuration of your digital camera is correct (see the manual of your digital camera for more information).
- Some digital cameras allow you to switch off the USB interface. Make sure that the USB interface is switched on before connecting to the TV.
- If you have a digital camera with only internal memory (no removable memory) you can try to copy the content manually to a USB memory device using a personal computer.
- Some digital cameras allow you to switch between PTP (Picture Transfer Protocol) or "PC Link" and USB Mass Storage. Make sure that you select USB Mass Storage or "PC Drive" on your digital camera.
- If your camera supports different interface settings be sure to try them one by one or contact the reseller of your camera to find out the correct setting.

USB Memory Device Issues

- Devices connected to the USB port of your TV must be "Mass Storage Class" compliant. If your device (digital camera, MP3 player, portable harddisk, ...) is not "Mass Storage Class" compliant it will not be detected by the content browser of the TV.
- The following subsets of the Mass Storage Class specification are supported:
The implementation of the TV is based on the "Universal Serial Bus Mass Storage Class Specification Overview" (v1.2, June 23, 2003) including all documents referenced by the document. The document can be found on the USB standardisation website (www.usb.org).
Full support of the USB Mass Storage Class Bulk-Only Transport (bInterfaceProtocol = 50h).
Full support of SubClass Code = 05h; SFF-8070i spec.
Full support of SubClass Code = 06h; SCSI transparent command set.
- For large USB memory devices, when you are in the Content Browser, it may take a long time before you can access your files.
- When using a USB portable harddisk: Due to the high power consumption of the harddisk, it is advised to use the external power supply of the portable harddisk to guarantee proper working under all conditions.

Digital Content Issues

- Only FAT (DOS) formatted (initialized) portable memory is supported. Errors in this formatting can result in unreadable content. If such problems appear try to re-format the card. Be aware that formatting the card will also delete all the content on it (pictures, music, ...).
- The maximum size of any multimedia file should never exceed 4Gbyte.
- Do not use a dot "." in folder naming.
- If video streams are supporting multiple audio tracks the first audio track will automatically be selected, the other audio tracks can't be selected.
- External subtitle files (e.g. DivX.srt subtitle files) are not supported.

The **HDMI IN** connector allows the following TV and monitor display modes:

HD	Standard Definition TV (SDTV)	640x480i 720x480i 720x576i
	Enhanced Definition TV (EDTV)	640x480p 720x480p 720x576p
	High Definition TV (HDTV)	1920x1080i 1280x720p
PC	VGA	640x480
	SVGA	800x600
	XGA	1024x768

- If necessary, you can adjust the picture position to the centre of the screen with the cursor keys.
- Due to legal requirements, it is possible that with certain copy protected PCM audio qualities from a peripheral equipment connected to the **HDMI** input, the Digital audio output signal is muted.
- Proper working is only guaranteed with HDMI compliant consumer products. Limit the cable length to maximum 5 m.
- In case no signal is detected from your HDMI equipment, switch off the HDMI equipment and then on again.

Sound interruptions using HDMI to HDMI connection

In case of persistent sound interruptions, connect an extra audio cable from your connected peripheral to your TV.

Extra analogue audio cable:

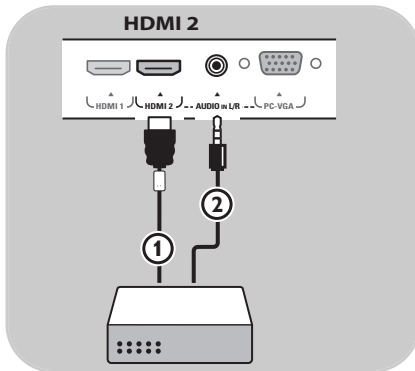

1. Connect your peripheral equipment with the **HDMI 2** connector ①.
2. Connect the analogue audio output of your peripheral equipment to the **AUDIO L/R** input of your TV ②.
3. Select the equipment you have connected in the Installation menu, Select your connections, p. 32, and link it to **HDMI 2**.
4. Also select **AUDIO IN L/R** in the same Connections menu.

Extra digital audio cable:

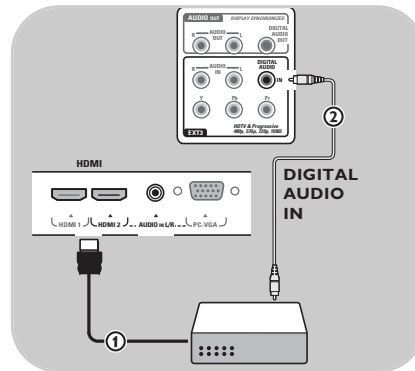

1. Connect your peripheral equipment with the **HDMI 1 or 2** connector ①.
2. Connect the digital audio output of your peripheral equipment to the **DIGITAL AUDIO IN** input of your TV ②.
3. Select the equipment you have connected in the Installation menu, Select your connections, p. 32, and link it to **HDMI 1 or 2**.
4. Also select **DIGITAL AUDIO IN** in the same Connections menu.

- active control 17
- ambilight 20
- analogue: manual installation. 29
- antenna..... 4
- audio receiver 51
- audio equipment keys..... 54
- auto format..... 17
- automatic installation..... 28
- avl (audio volume leveller)..... 19

- balance 18
- batteries 4, 64
- brightness 15

- camera 44
- camcorder 44
- care of the screen 2
- change code 25
- channel list..... 11,34
- child lock 24
- clock 7
- colour..... 15
- colour enhancement..... 17
- colour keys..... 5
- common interface slot..... 26
- comp. video connectors.....47,49
- connections..... 43
- contrast 15
- country selection..... 28
- cursor keys..... 5
- custom colour..... 22
- custom tint..... 16

- decoder..... 32
- delta volume 19
- demo 26
- digital audio language..... 18
- digital natural motion 16
- digital subtitle language 23
- digital teletext 42
- digital: test reception 29
- digital TV 8
- DNR 16
- dual I/II 19
- DVB-T 8
- DVD player 48
- DVD recorder..... 47
- DVI connector..... 48,50
- dynamic contrast 16

- EPG 35
- equalizer 19
- euroconnector 46,47,51

- factory settings..... 33
- favourite key 34
- favourite channel list..... 34
- features adjustment menu 23
- fine tune..... 29
- first time installation 9

- game..... 44,48
- HDMI connector 48
- headphone..... 44
- headphone volume..... 19
- hearing impaired..... 23,27
- home cinema amplifier 51
- hue 15
- hypertext..... 41

- installation menu..... 27
- language preferences..... 27
- light sensor 17
- location 31

- manual installation 29
- menu key 11
- MPEG reduction 17
- multimedia browser 37
- mute key 5

- navigate through the menus.. 11

- on screen language..... 9
- on screen information 6
- on timer..... 25
- option key 7
- OK key..... 5

- PC 50
- picture adjustment menu..... 15
- picture format 17
- PIN code 25
- pixel plus..... 16
- preferences menu..... 31
- preferred audio language 27
- preferred subtitle language.... 27
- previous channel 6
- programme title 31

- quick access menu 7

- radio channels 28
- rear panel overview 45
- rearrange channel list 30
- record a TV programme 53
- recycling..... 64
- reinstall 30
- remote control..... 5
- reset factory settings 33
- rename 30
- reshuffle 30

- safety warnings 2
- satellite receiver 49
- search for channels 27
- select your connections..... 32
- select connected equipment. 53
- set code 25
- settings assistant 10
- side connectors 44
- sharpness..... 15
- sleeptimer 24
- slideshow format 60
- software upgrade 33,57
- sound adjustment menu..... 18
- standby key..... 5
- store channels 28
- subtitles..... 23
- surround mode 19
- switch the TV on..... 8

- teletext 40
- teletext menu..... 41
- teletext 2.5..... 31
- time zone selection..... 28
- tint 15
- T.O.P. teletext pages..... 40
- troubleshooting..... 55
- tv menu settings 13

- uninstall..... 30
- usb connector 44
- usb device..... 37

- video equipment keys..... 54
- volume 5
- VCR 46

Recycling

 The packaging of this product is intended to be recycled. Apply to the local authorities for correct disposal.

The batteries supplied do not contain the heavy metals mercury and cadmium. Please check on how to dispose of exhausted batteries according to local regulations.

Disposal of your old product

Your product is designed and manufactured with highly quality material and components, which can be recycled and reused.



When this crossed-out wheeled bin symbol is attached to a product, it means the product is covered by the European Directive 2002/96/EC.

Please inform yourself about the local separate collection system for electrical and electronic products. Please act according to your local rules and do not dispose of your old products with your normal household waste.

The correct disposal of your old product will help prevent potential negative consequences for the environment and human health.

Product information

- Your TV consumes energy in standby mode. Energy consumption contributes to air and water pollution. Very low standby power consumption.
- Specifications: see the product leaflet on www.philips.com/support.
- If you need further assistance, please call the customer support service in your country. The corresponding telephone numbers and addresses are given in the supplied Worldwide guarantee booklet.



België / Belgique 070 222 303	€0.17/min	Ireland 01 601 1777	Local	Portugal 2 1359 1442	Local
Danmark 3525 8759	Local	Italia 199 404 041	€0.25/min	Schweiz / Suisse / Svizzera 0844 800 544	Local
Deutschland 0180 5 356 767	€0.12/min	Luxembourg 40 6661 5644	Local	Svenska 08 5792 9100	Local
France 08 9165 0005	€0.23/min	Nederland 0900 8407	€0.20/min	Suomi 09 2311 3415	Local
ΕΛΛΑΣ 0 0800 3122 1280	Δωρεάν	Norge 2270 8111	Local	United Kingdom 0906 1010016	£0.15/min
España 902 888 784	€0.15/min	Österreich 0820 901114	€0.20/min		